



Luxera
Lighting



-Efficiency:85Lm/W

-Body of aluminum

Order No.	Power(W)	Voltage(V)	CRI	Beam Angle(°)	SIZE(MM)
KDR-66056-1	5	100-240	85	15/25/40	Φ 60*H110
KDR-66056-2	2*5	100-240	85	15/25/40	Φ 60*H170



UPDATES







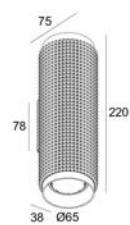
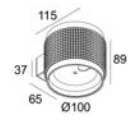
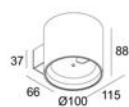
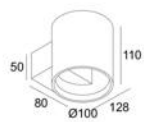

PUNK

FAMILY

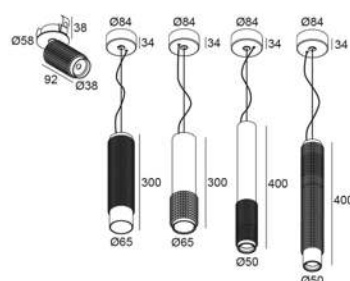



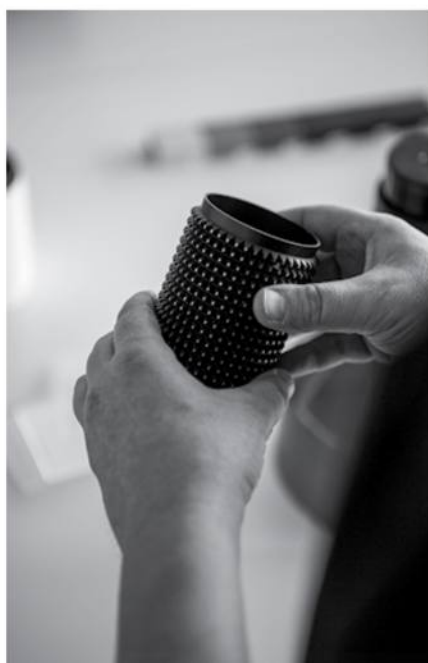
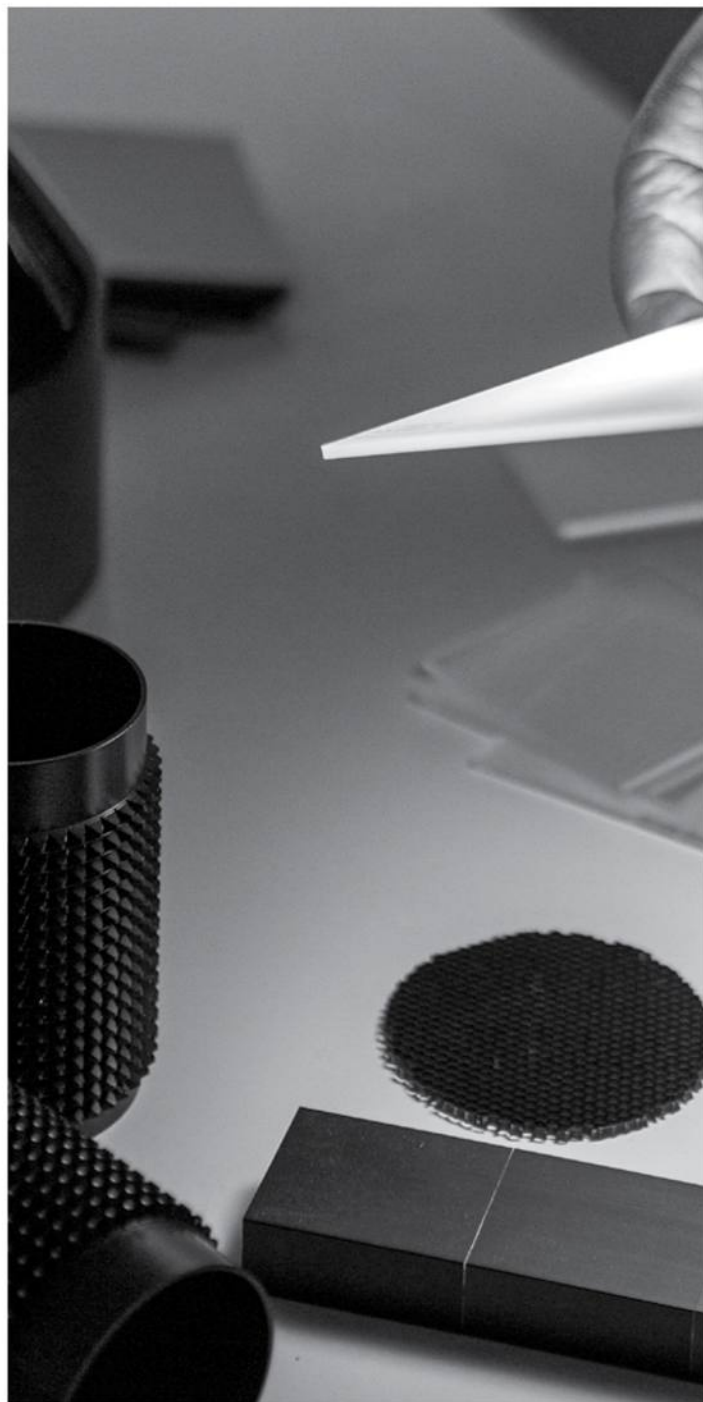





-Efficiency:85Lm/W

-Body of aluminum

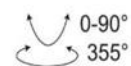
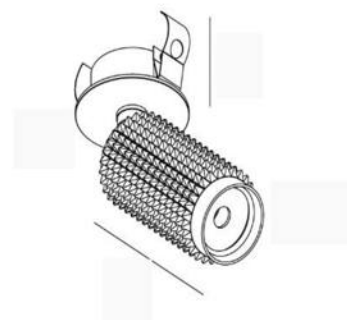

Order No.	Power(W)	Voltage(V)	CRI	Beam Angle(°)	SIZE(MM)
KDR-94045-RE	5	100-240	90	15/25/40	Φ52*130





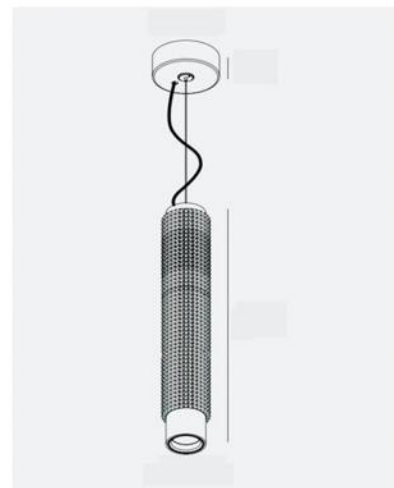

CE | RoHS | IP20 | 

-Efficiency:85Lm/W

-Body of aluminum

Order No.	Power(W)	Voltage(V)	CRI	Beam Angle(°)	SIZE(MM)
KDR-94045-PD-A	5	100-240	90	15/25/40	Φ 52*H100
KDR-94045-PD-B	5	100-240	90	15/25/40	Φ 52*H210
KDR-94045-PD-C	5	100-240	90	15/25/40	Φ 52*H400



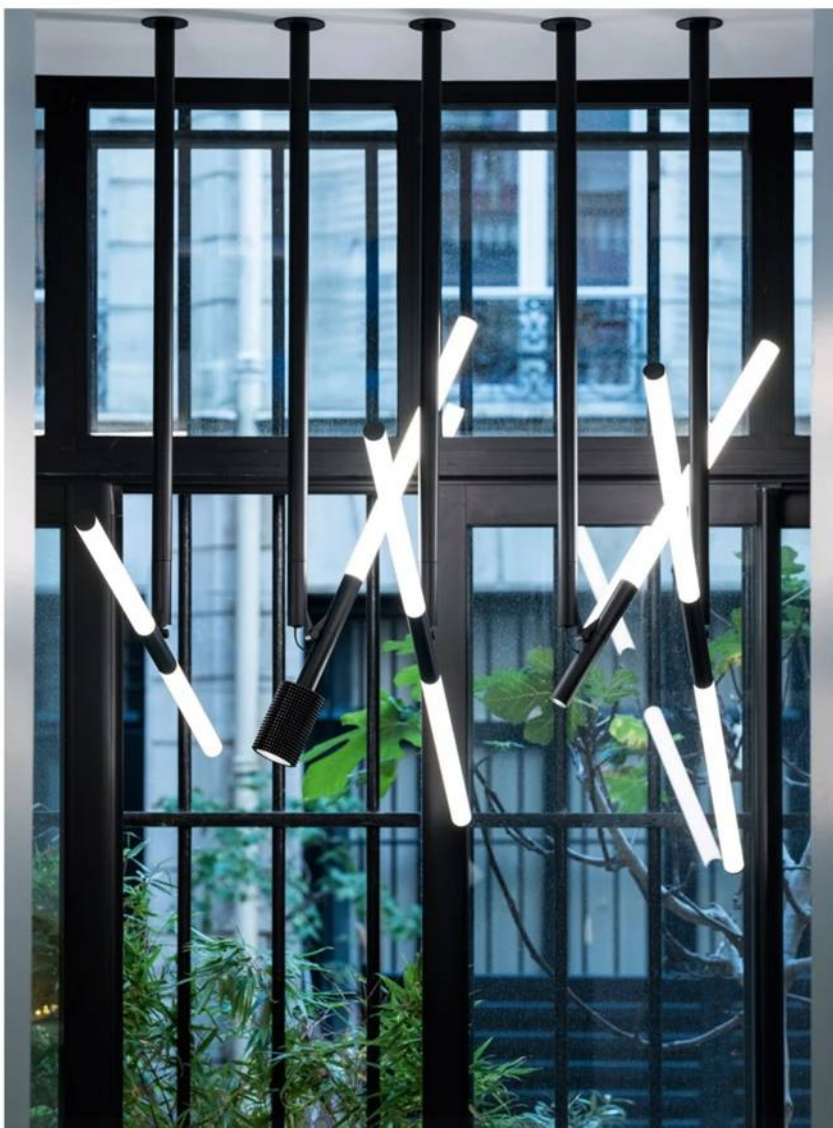

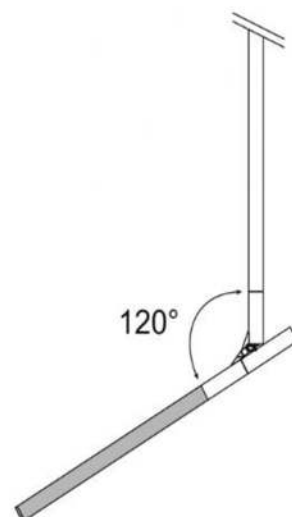
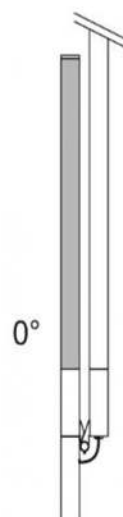

-Efficiency:85Lm/W

-Body of aluminum

Order No.	Power(W)	Voltage(V)	CRI	Beam Angle(°)	SIZE(MM)
KDR-94045-SF	7	100-240	90	15/25/40	Φ 52-460





CE | RoHS | IP65 | 

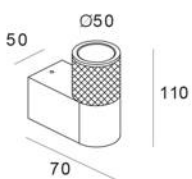

-Efficiency:85Lm/W

-Body of aluminum

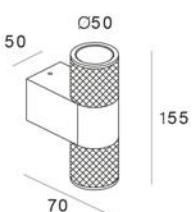

Order No.	Power(W)	Voltage(V)	CRI	Beam Angle(°)	SIZE(MM)
KDR-67400-W-1	5	100-240	90	15/25/40	Φ 50*H110
KDR-67400-W-2	2*5	100-240	90	15/25/40	Φ 50*H155



- Efficiency:85Lm/W
- 主体使用纯铝
- Body of aluminum

Order No.	Power(W)	Voltage(V)	CRI	Beam Angle(°)	SIZE(MM)
KDR-94052-Z	5	100-240	90	15/25/40	Φ 50*H90



Luxera Lighting

www.luxeralighting.ro

 **+40 728 401 242**



Șoseaua București
Urziceni 25, Afumați 077010,
Romania