



CATALOG

CORPURI DE ILUMINAT

Exterior **LED 2020**





l u x e r a l i g h t i n g . r o

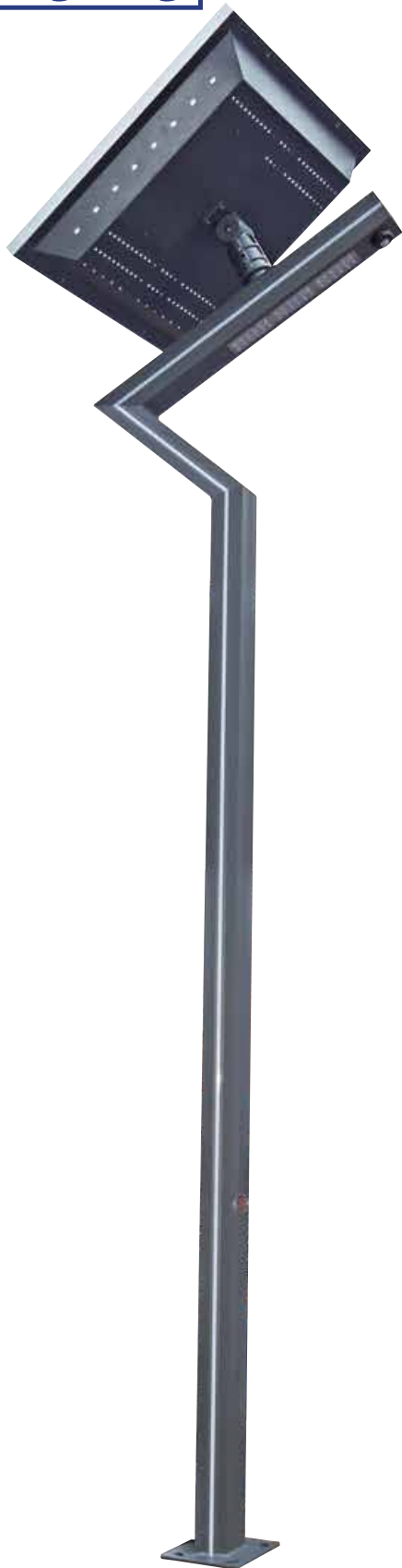

JB-SL001B1

LED Garden Light

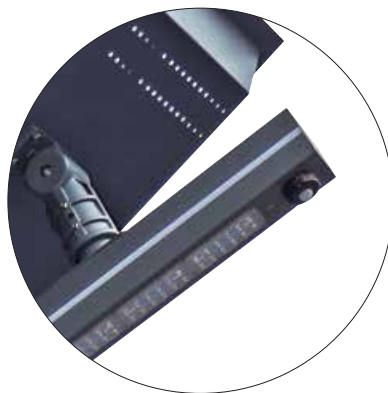

Material and Technology:

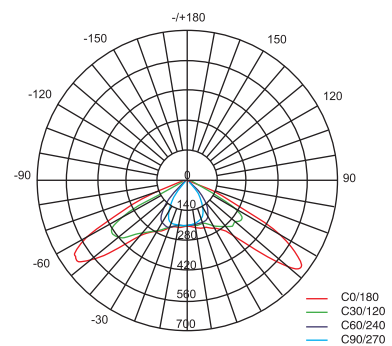

- The product design creating is concise and fashion/delicate and elegant/classics and romantic/perfect combination and city beautification.
- The lamp body using for 6063 aluminum material,the lamp pole is high tenacity and metal material will be high reclaim.
- The light source with high quality LED chips and power supply,the lamp pole two side with LED strip for color:red/blue/green/yellow/white and RGB full color change.
- The lamp pole with Nano multi-fanctional coating/prevent paste/prevent scrawl/prevent scratching.
- The lamp application places:public garden/bussiness area/luxury villa garden/ park/plaza/pavements of road ,etc.

Light Distribution Curve



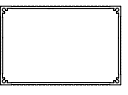

Technology information

Product Code	JB-SL001A1	JB-SL001B1	JB-SL001C1
Lamp size	 150 × 100mm	 150 × 75mm	 130 × 85mm
Product height	4M-6M	3M-4M	3M-3.5M
Power	30W	20W	20W
Lamp material	6063 Aluminum material		
Color temp	3000K / 6000K		
Strip color temp	Blue / Green / Red / Pink / Warm white		
LED chips	PHILIPS / CREE / BRIGDELUX		
Lens angle	120°*70°		
Efficiency	87%		
Protection levels	IP65		



JB-SL002C1

JB-SL126I2

JB-SL129I2

Product description

Material and Technology:

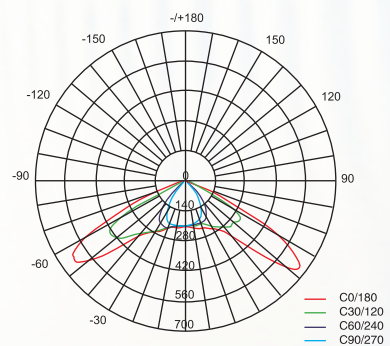

- The product design creating is concise and fashion/delicate and elegant/classics and romantic/perfect combination and city beautification.
- The lamp body using for 6063 aluminum material,the lamp pole is high tenacity and metal material will be high reclaim.
- The light source with high quality LED chips and power supply,the lamp pole two side with LED strip for color:red/blue/green/yellow/white and RGB full color change.
- The lamp pole with Nano multi-fanctional coating/prevent paste/prevent scrawl/prevent scratching.
- The lamp application places:public garden/bussiness area/luxury villa garden/ park/plaza/pavements of road ,etc.

Light Distribution Curve





Technology information

Product Code	JB-SL002C1	JB-SL126I2	JB-SL129I2
Lamp size	 130 × 85mm	 230 × 80mm	 150 × 100mm
Product height	3M-4M	3M-4M	3M-4M
Power	30-40W	30-40W	30-40W
Lamp material	6063 Aluminum material		
Color temp	3000K / 6000K		
Strip color temp	Blue / Green / Red / Pink / Warm white		
LED chips	PHILIPS / CREE / BRIGDELUX		
Lens angle	120°*70°		
Efficiency	87%		
Protection levels	IP65		

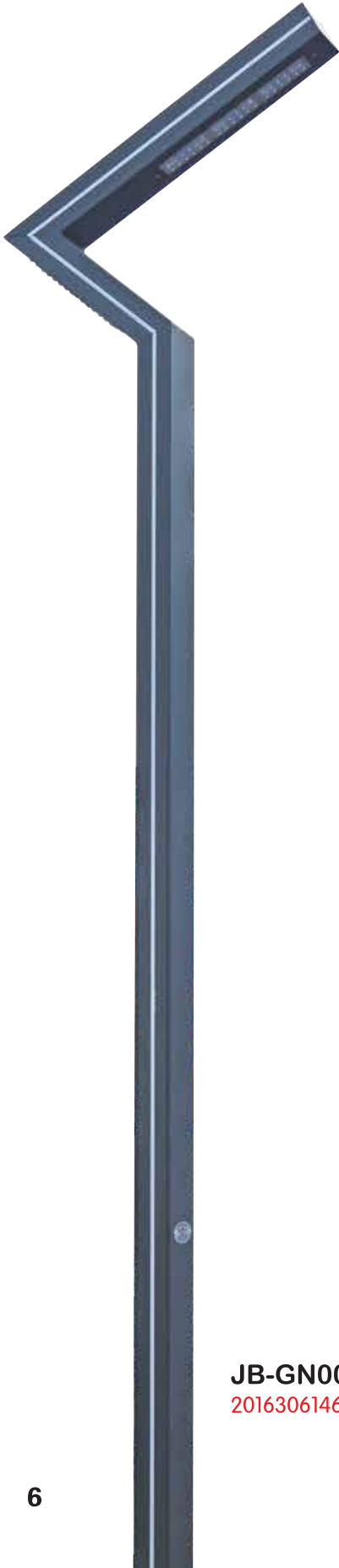

Product description

Material and Technology:

- The product design creating is concise and fashion/delicate and elegant/classics and romantic/perfect combination and city beautification.
- The lamp body using for 6063 aluminum material,the lamp pole is high tenacity and metal material will be high reclaim.
- The light source with high quality LED chips and power supply,the lamp pole two side with LED strip for color:red/blue/green/yellow/white and RGB full color change.
- The lamp pole with Nano multi-functional coating/prevent paste/prevent scrawl/prevent scratching.
- The lamp application places:public garden/bussiness area/luxury villa garden/ park/plaza/pavements of road ,etc.

Light Distribution Curve

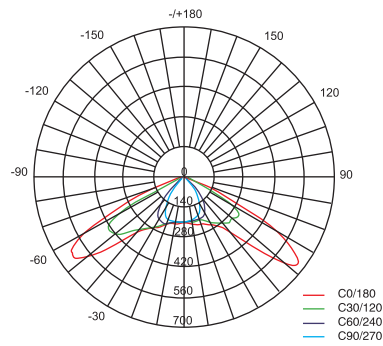

JB-GN001
201630614652.4



JB-GN001E1

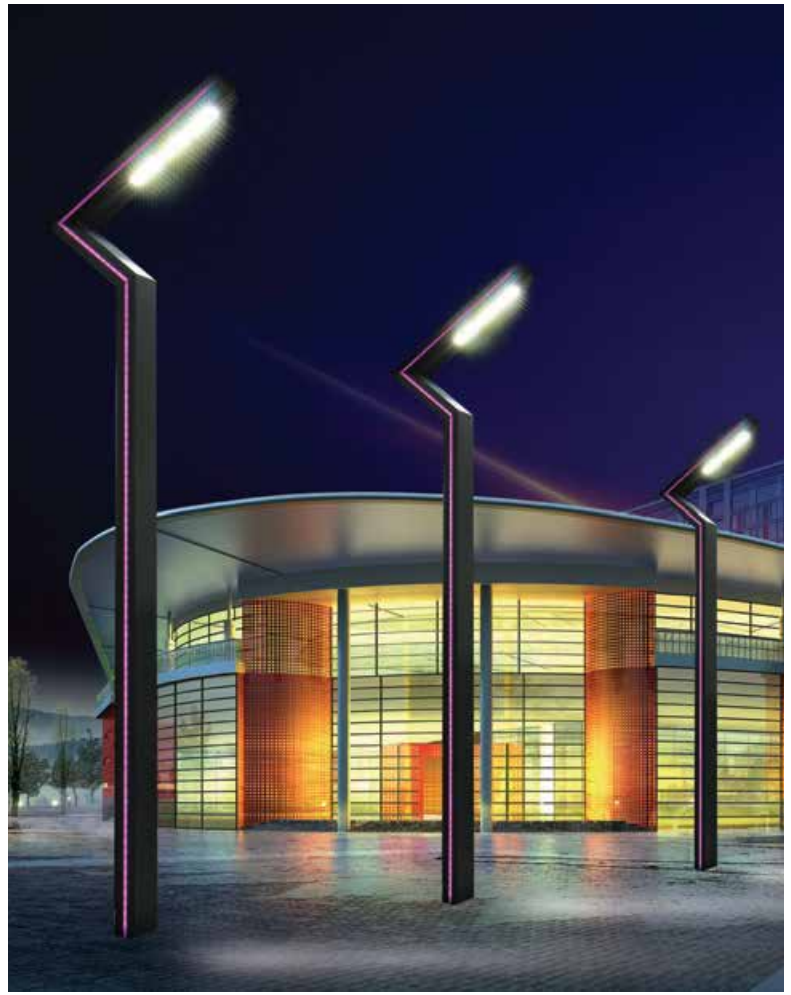

JB-GN001A2

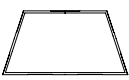
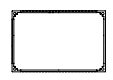

Technology information

Product Code	JB-GN001A1	JB-GN001B1	JB-GN001C1	JB-GN001E1
Lamp size	 150 x 100mm	 150 x 75mm	 130 x 85mm	 150 x 60mm
Product height	4M-6M	3M-4M	3M-3.5M	3M-4M
Power	30W - 60W	20W / 30W	20W / 30W	20W / 30W
Lamp material	6063 Aluminum material			
Color temp	3000K / 6000K			
Strip color temp	Blue / Green / Red / Pink / Warm white			
LED chips	PHILIPS / CREE / BRIGDELUX			
Power supply	PHILIPS driver / MW driver from taiwan / MOSO®			
Lens angle	120*70°			
Efficiency	87%			
Input voltage	AC85-265V			
Protection levels	IP65			



LED Garden Light

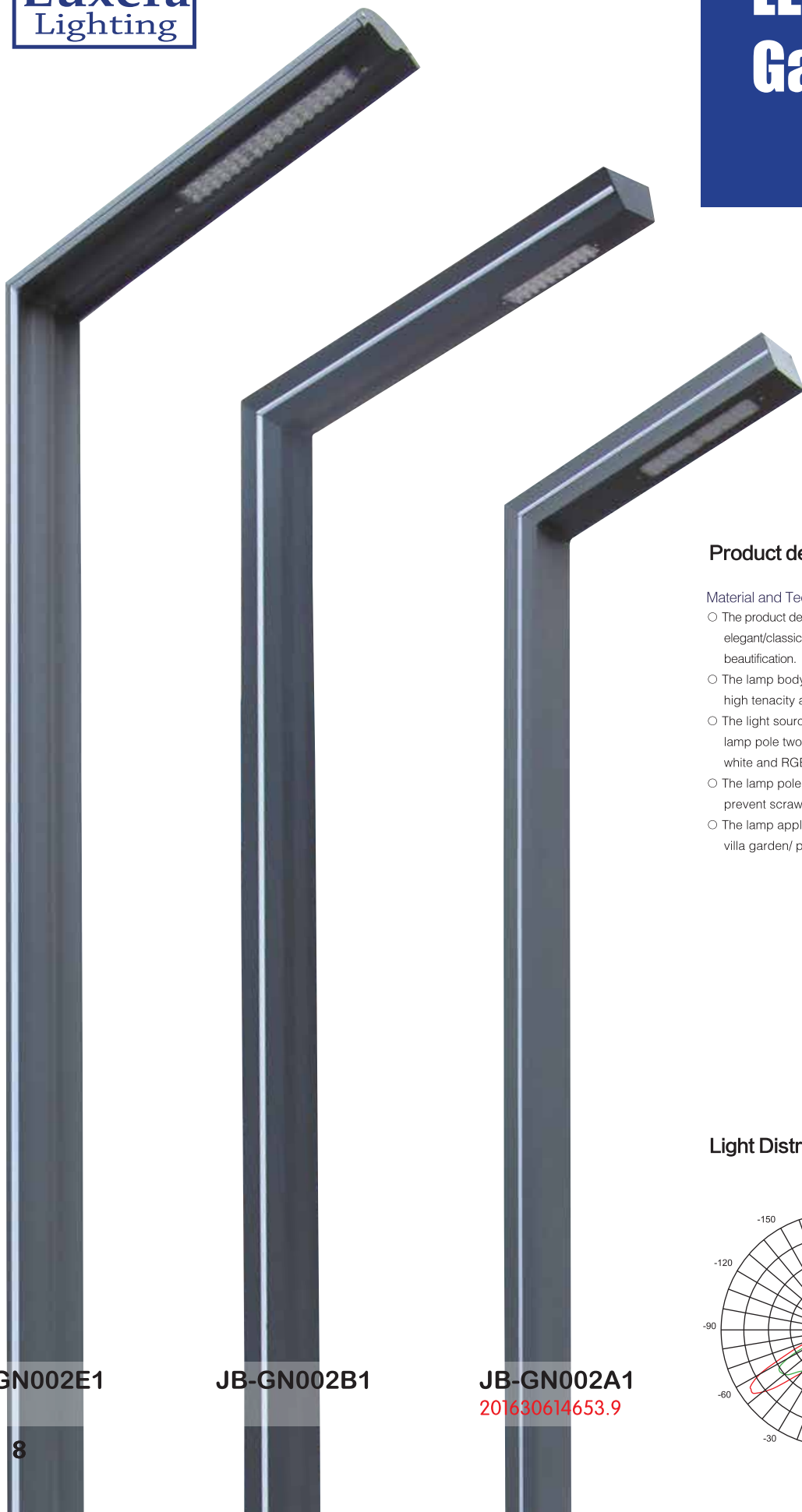

Product description

Material and Technology:

- The product design creating is concise and fashion/delicate and elegant/classics and romantic/perfect combination and city beautification.
- The lamp body using for 6063 aluminum material,the lamp pole is high tenacity and metal material will be high reclaim.
- The light source with high quality LED chips and power supply,the lamp pole two side with LED strip for color:red/blue/green/yellow/white and RGB full color change.
- The lamp pole with Nano multi-fanctional coating/prevent paste/prevent scrawl/prevent scratching.
- The lamp application places:public garden/bussiness area/luxury villa garden/ park/plaza/pavements of road ,etc.

Light Distribution Curve

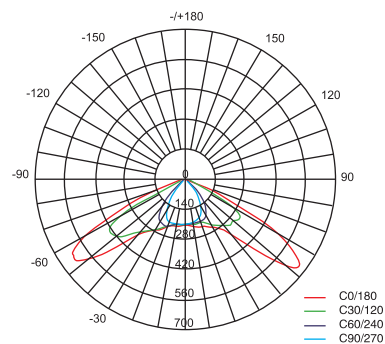



JB-GN002E1

JB-GN002B1

JB-GN002A1
201630614653.9

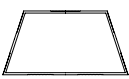

Technology information

Product Code	JB-GN002A1	JB-GN002B1	JB-GN002C1	JB-GN002E1
Lamp size	 150 × 100mm	 150 × 75mm	 130 × 85mm	 150 × 60mm
Product height	4M-6M	3M-4M	3M-3.5M	3M-4M
Power	30W - 60W	20W / 30W	20W / 30W	20W / 30W
Lamp material	6063 Aluminum material			
Color temp	3000K / 6000K			
Strip color temp	Blue / Green / Red / Pink / Warm white			
LED chips	PHILIPS / CREE / BRIGDELUX			
Power supply	PHILIPS driver / MW driver from taiwan / MOSO®			
Lens angle	120°*70°			
Efficiency	87%			
Input voltage	AC85-265V			
Protection levels	IP65			

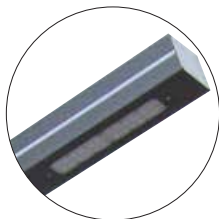
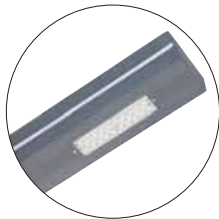



CE FC RoHS

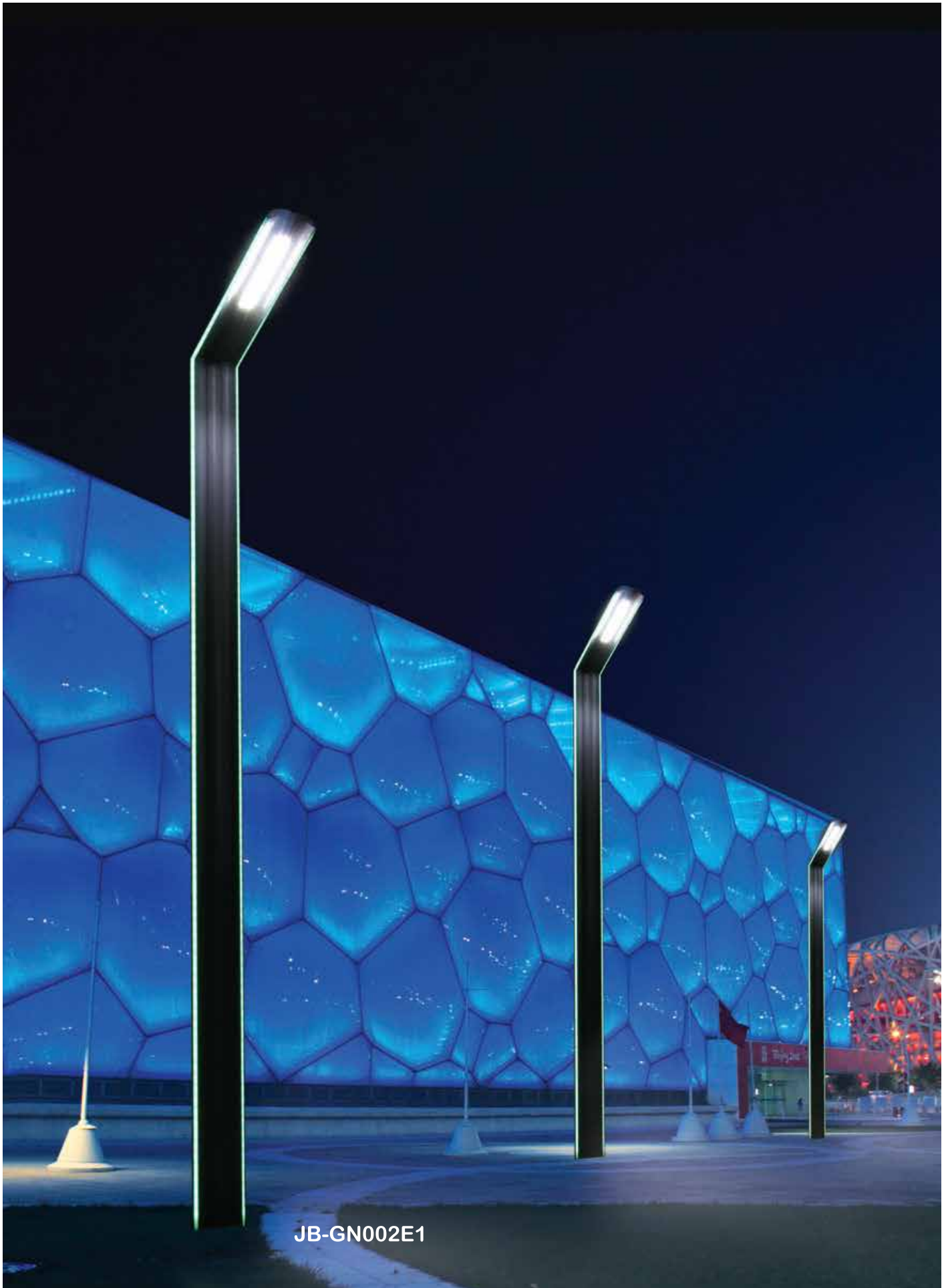

JB-GN002E1

Product description

Material and Technology:

- The product design creating is concise and fashion/delicate and elegant/classics and romantic/perfect combination and city beautification.
- The lamp body using for 6063 aluminum material,the lamp pole is high tenacity and metal material will be high reclaim.
- The light source with high quality LED chips and power supply,the lamp pole two side with LED strip for color:red/blue/green/yellow/white and RGB full color change.
- The lamp pole with Nano multi-fanctional coating/prevent paste/prevent scrawl/prevent scratching.
- The lamp application places:public garden/bussiness area/luxury villa garden/ park/plaza/pavements of road ,etc.



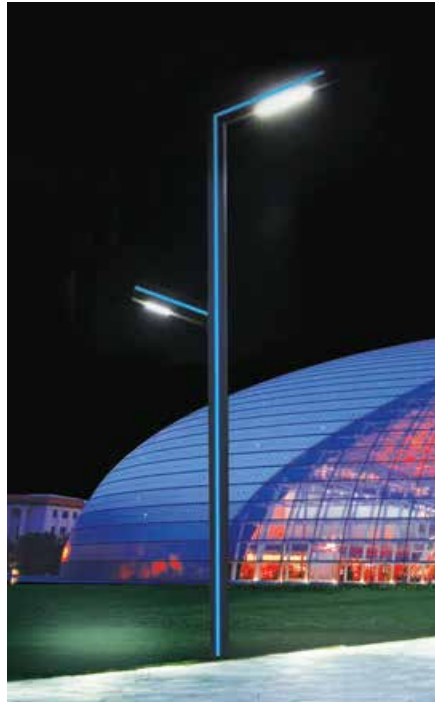
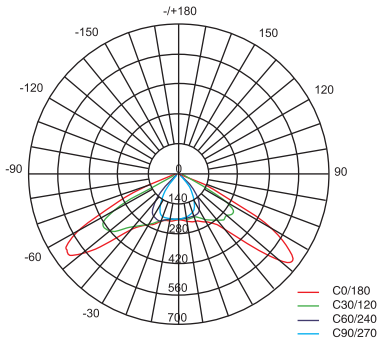

JB-GN002A2
201630614651.X

JB-GN002C3
201630614801.7

Light Distribution Curve



Technology information

Product Code	JB-GN002A2	JB-GN002C2	JB-GN002A3	JB-GN002C3
Lamp size	 150 x 100mm	 130 x 85mm	 150 x 100mm	 130 x 85mm
Product height	4M-6M	3M-3.5M	4M-6M	3M-3.5M
Power	30W+10W-60W+20W	20W+10W/30W+10W	2 x 30W-2 x 60W	2 x 20W/2 x 30W
Lamp material	6063 Aluminum material			
Color temp	3000K / 6000K			
Strip color temp	Blue / Green / Red / Pink / Warm white			
LED chips	PHILIPS / CREE / BRIGDELUX			
Power supply	PHILIPS driver / MW driver from taiwan / MOSO®			
Lens angle	120°70°			
Efficiency	87%			
Input voltage	AC85-265V			
Protection levels	IP65			

LED Garden Light



JB-GN126I2

JB-GN126I1
201630614655.8

JB-GN001I1
201630614802.1

Product description

Material and Technology:

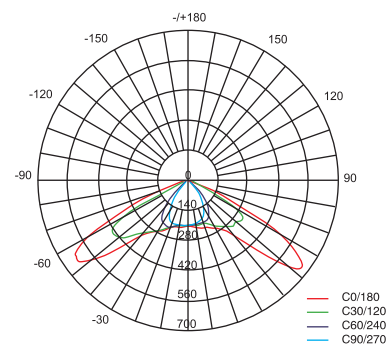

- The product design creating is concise and fashion/delicate and elegant/classics and romantic/perfect combination and city beautification.
- The lamp body using for 6063 aluminum material,the lamp pole is high tenacity and metal material will be high reclaim.
- The light source with high quality LED chips and power supply,the lamp pole two side with LED strip for color:red/blue/green/yellow/white and RGB full color change.
- The lamp pole with Nano multi-fanctional coating/prevent paste/prevent scrawl/prevent scratching.
- The lamp application places:public garden/bussiness area/luxury villa garden/ park/plaza/pavements of road ,etc.

Light Distribution Curve





Technology information

Product Code	JB-GN00111	JB-GN12611	JB-GN12612
Lamp size	 230 x 80mm	 230 x 80mm	 230 x 80mm
Product height	3M-4M	3M-4M	3M-4M
Power	30W	30W	30W
Lamp material	6063 Aluminum material		
Color temp	3000K / 6000K		
Strip color temp	Blue / Green / Red / Pink / Warm white		
LED chips	PHILIPS / CREE / BRIGDELUX		
Lens angle	120*70°		
Efficiency	87%		
Protection levels	IP65		

LED Garden Light

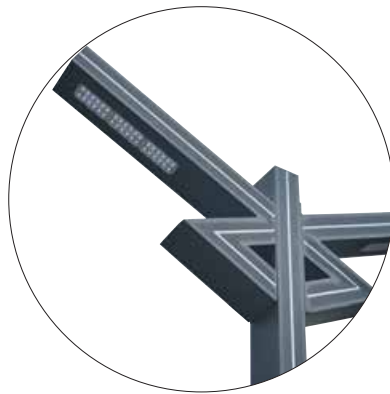

Product description

Material and Technology:

- The product design creating is concise and fashion/delicate and elegant/classics and romantic/perfect combination and city beautification.
- The lamp body using for 6063 aluminum material,the lamp pole is high tenacity and metal material will be high reclaim.
- The light source with high quality LED chips and power supply,the lamp pole two side with LED strip for color:red/blue/green/yellow/white and RGB full color change.
- The lamp pole with Nano multi-factional coating/prevent paste/prevent scrawl/prevent scratching.
- The lamp application places:public garden/bussiness area/luxury villa garden/ park/plaza/pavements of road ,etc.

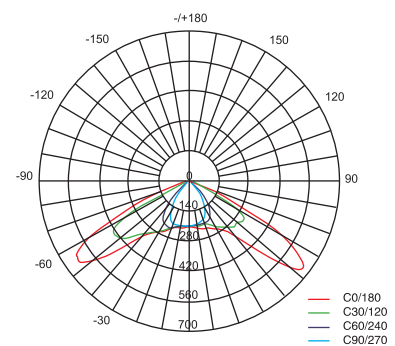

Light Distribution Curve



JB-GN010C1
201630614681.0



Technology information

Product Code	JB-GN010A1	JB-GN010C1
Lamp size	 150 × 100mm	 130 × 85mm
Product height	4M-6M	3M-4M
Power	2 × 30W - 2 × 60W	2 × 20W / 2 × 30W
Lamp material	6063 Aluminum material	
Color temp	3000K / 6000K	
Strip color temp	Blue / Green / Red / Pink / Warm white	
LED chips	PHILIPS / CREE / BRIGDELUX	
Power supply	PHILIPS driver / MW driver from taiwan / MOSO®	
Lens angle	120°70°	
Efficiency	87%	
Input voltage	AC85-265V	
Protection levels	IP65	



JB-GN003B1



JB-GN003EY2
201630614654.3

Product description

Material and Technology:

- The product design creating is concise and fashion/delicate and elegant/classics and romantic/perfect combination and city beautification.
- The lamp body using for 6063 aluminum material,the lamp pole is high tenacity and metal material will be high reclaim.
- The light source with high quality LED chips and power supply,the lamp pole two side with LED strip for color:red/blue/green/yellow/white and RGB full color change.
- The lamp pole with Nano multi-fanctional coating/prevent paste/prevent scrawl/prevent scratching.
- The lamp application places:public garden/bussiness area/luxury villa garden/ park/plaza/pavements of road ,etc.



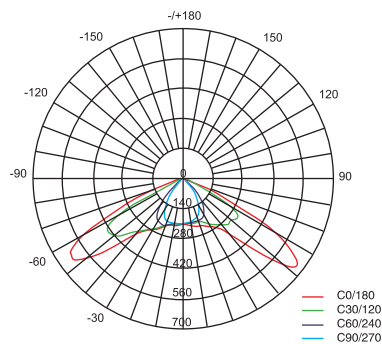

Light Distribution Curve





JB-GN003E1

Technology information

Product Code	JB-GN003A1	JB-GN003B1	JB-GN003C1	JB-GN003E1	JB-GN003EY2
Lamp size	 150 × 100mm	 150 × 75mm	 130 × 85mm	 150 × 60mm	 150 × 60mm + Φ89mm
Product height	4M-6M	3M-4M	3M-4M	3M-4M	3M-4M
Power	30W+10W 60W+20W	20W+10W / 30W+10W		20W-40W	20W+7W 30W+7W
Lamp material	6063 Aluminum material				
Color temp	3000K / 6000K				
Strip color temp	Blue / Green / Red / Pink / Warm white				
LED chips	PHILIPS / CREE / BRIGDELUX				
Power supply	PHILIPS driver / MW driver from taiwan / MOSO®				
Lens angle	120°70°				
Efficiency	87%				
Input voltage	AC85-265V				
Protection levels	IP65				



LED Garden Light



JB-GN129I1
201630614720.7



JB-GN005A1

Product description

Material and Technology:

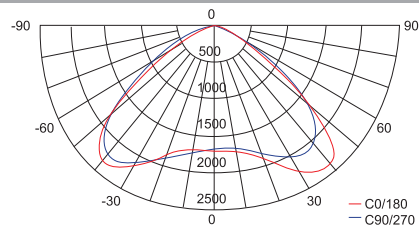

- The product design creating is concise and fashion/delicate and elegant/classics and romantic/perfect combination and city beautification.
- The lamp body using for 6063 aluminum material,the lamp pole is high tenacity and metal material will be high reclaim.
- The light source with high quality LED chips and power supply,the lamp pole two side with LED strip for color:red/blue/green/yellow/white and RGB full color change.
- The lamp pole with Nano multi-fanctional coating/prevent paste/prevent scrawl/prevent scratching.
- The lamp application places:public garden/bussiness area/luxury villa garden/ park/plaza/pavements of road ,etc.

Light Distribution Curve



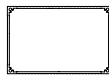

Technology information

Product Code	JB-GN005A1	JB-GN005C1	JB-GN12911
Lamp size	 150 x 100mm	 130 x 85mm	 200 x 100mm
Product height	4M-6M	3M-3.5M	3M-4M
Power	40W	40W	36W
Lamp material	6063 Aluminum material		
Color temp	3000K / 6000K		
Strip color temp	Blue / Green / Red / Pink / Warm white		
LED chips	PHILIPS / CREE / BRIGDELUX		
Power supply	PHILIPS driver / MW driver from taiwan / MOSO®		
Lens angle	120*70°		
Efficiency	87%		
Input voltage	AC85-265V		
Protection levels	IP65		

LED Garden Light

Product description

Material and Technology:

- The product design creating is concise and fashion/delicate and elegant/classics and romantic/perfect combination and city beautification.
- The lamp body using for 6063 aluminum material,the lamp pole is high tenacity and metal material will be high reclaim.
- The light source with high quality LED chips and power supply,the lamp pole two side with LED strip for color:red/blue/green/yellow/white and RGB full color change.
- The lamp pole with Nano multi-fanctional coating/prevent paste/prevent scrawl/prevent scratching.
- The lamp application places:public garden/bussiness area/luxury villa garden/ park/plaza/pavements of road ,etc.

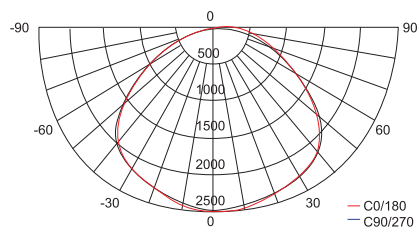

Light Distribution Curve



JB-GN004
201630614804.0



Technology information

Product Code	JB-GN004A1	JB-GN004C1
Lamp size	 150 × 100mm	 130 × 85mm
Product height	4M-6M	3M-3.5M
Power	30W-40W	30W-40W
Lamp material	6063 Aluminum material	
Color temp	3000K / 6000K	
Strip color temp	Blue / Green / Red / Pink / Warm white	
LED chips	PHILIPS / CREE / BRIGDELUX	
Power supply	PHILIPS driver / MW driver from taiwan / MOSO [®]	
Lens angle	120°70°	
Efficiency	87%	
Input voltage	AC85-265V	
Protection levels	IP65	

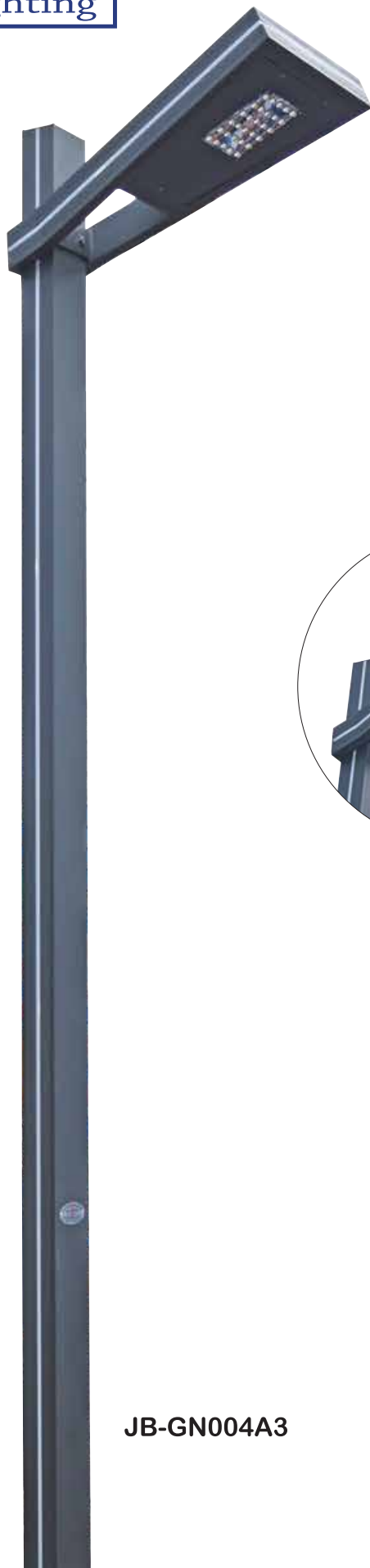

LED Garden Light

Product description

Material and Technology:

- The product design creating is concise and fashion/delicate and elegant/classics and romantic/perfect combination and city beautification.
- The lamp body using for 6063 aluminum material,the lamp pole is high tenacity and metal material will be high reclaim.
- The light source with high quality LED chips and power supply,the lamp pole two side with LED strip for color:red/blue/green/yellow/white and RGB full color change.
- The lamp pole with Nano multi-fanctional coating/prevent paste/prevent scrawl/prevent scratching.
- The lamp application places:public garden/bussiness area/luxury villa garden/ park/plaza/pavements of road ,etc.

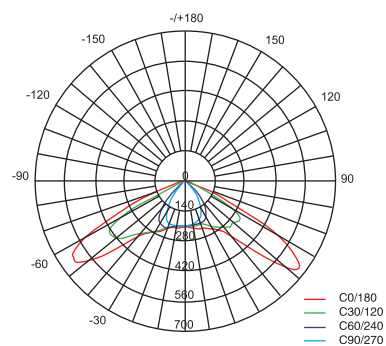

Light Distribution Curve



JB-GN004A3



Technology information

Product Code	JB-GN004A3	JB-GN004C3
Lamp size	 150 x 100mm	 130 x 85mm
Product height	4M-6M	3M-4M
Power	30W-40W	30W-40W
Lamp material	6063 Aluminum material	
Color temp	3000K / 6000K	
Strip color temp	Blue / Green / Red / Pink / Warm white	
LED chips	PHILIPS / CREE / BRIGDELUX	
Power supply	PHILIPS driver / MW driver from taiwan / MOSO®	
Lens angle	120°70°	
Efficiency	87%	
Input voltage	AC85-265V	
Protection levels	IP65	

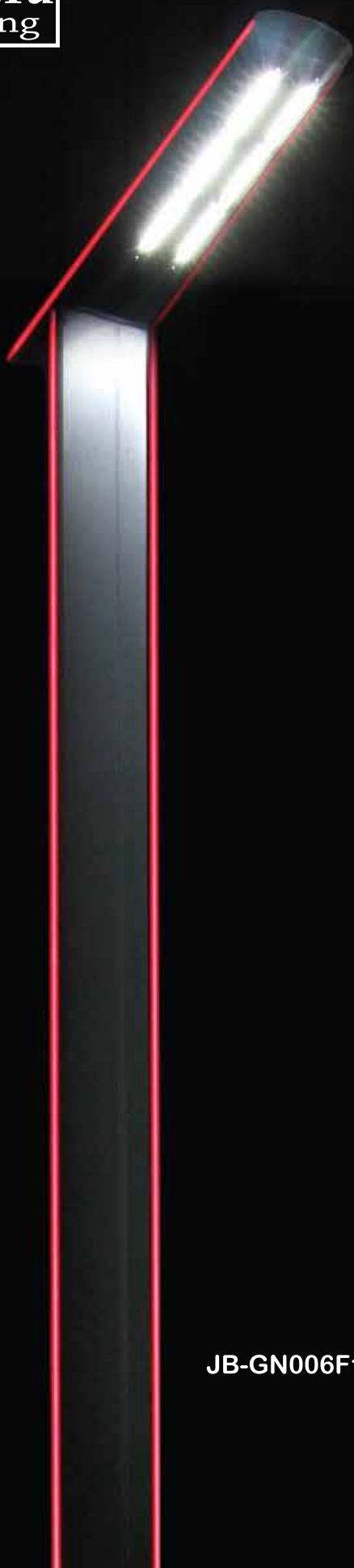

JB-GN006F1

LED Garden Light

Product description

- Material and Technology:
- The product design creating is concise and fashion/delicate and elegant/classics and romantic/perfect combination and city beautification.
 - The lamp body using for 6063 aluminum material,the lamp pole is high tenacity and metal material will be high reclaim.
 - The light source with high quality LED chips and power supply,the lamp pole two side with LED strip for color:red/blue/green/yellow/white and RGB full color change.
 - The lamp pole with Nano multi-functional coating/prevent paste/prevent scrawl/prevent scratching.
 - The lamp application places:public garden/bussiness area/luxury villa garden/ park/plaza/pavements of road ,etc.

Light Distribution Curve

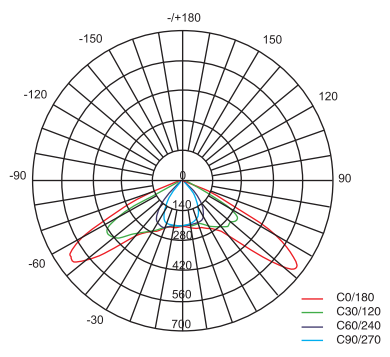



Technology information

Product Code	JB-GN006F1
Lamp size	 200 x 100mm
Product height	3M-4M
Power	30W
Lamp material	6063 Aluminum material
Color temp	3000K / 6000K
Strip color temp	Blue / Green / Red / Pink / Warm white
LED chips	PHILIPS / CREE / BRIGDELUX
Power supply	PHILIPS driver / MW driver from taiwan / MOSO®
Lens angle	120°70°
Efficiency	87%
Input voltage	AC85-265V
Protection levels	IP65

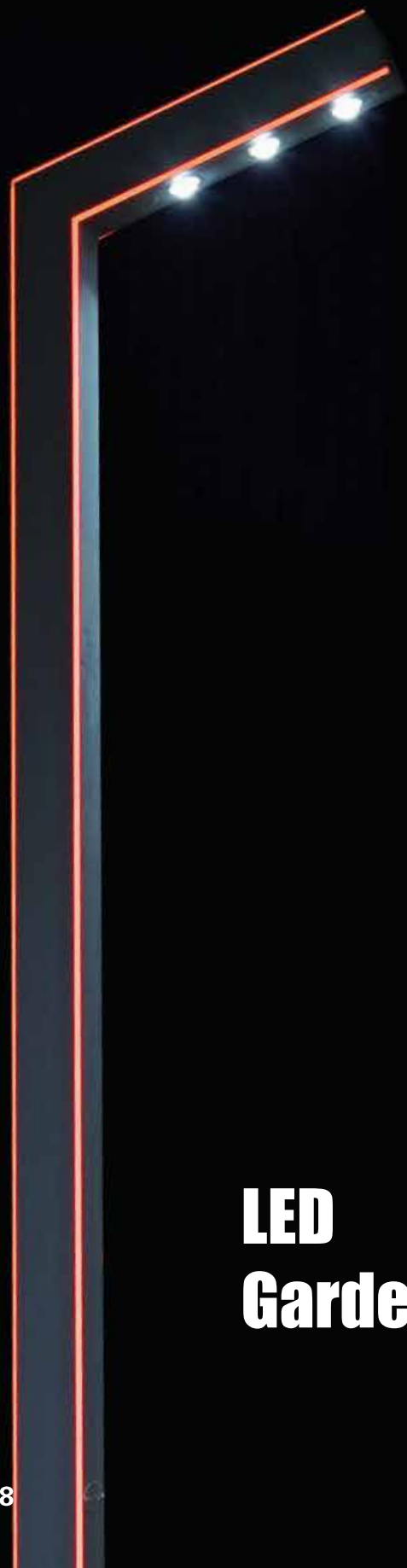

LED Garden Light

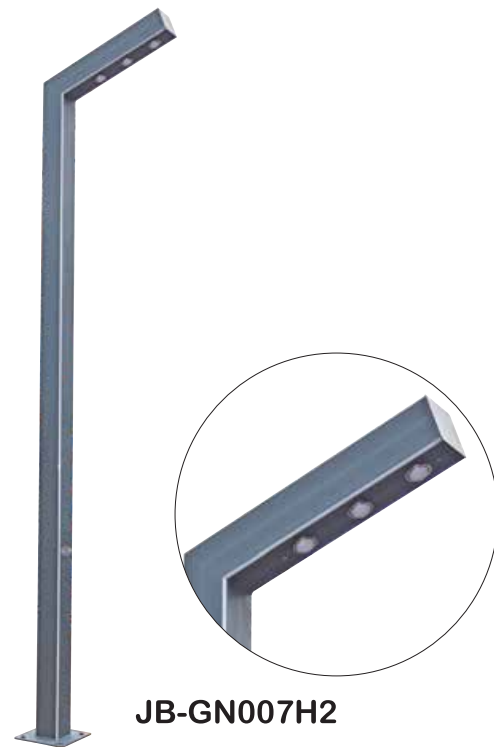

JB-GN007H2

Product description

Material and Technology:

- The product design creating is concise and fashion/delicate and elegant/classics and romantic/perfect combination and city beautification.
- The lamp body using for 6063 aluminum material,the lamp pole is high tenacity and metal material will be high reclaim.
- The light source with high quality LED chips and power supply,the lamp pole two side with LED strip for color:red/blue/green/yellow/white and RGB full color change.
- The lamp pole with Nano multi-fanctional coating/prevent paste/prevent scrawl/prevent scratching.
- The lamp application places:public garden/bussiness area/luxury villa garden/ park/plaza/pavements of road ,etc.



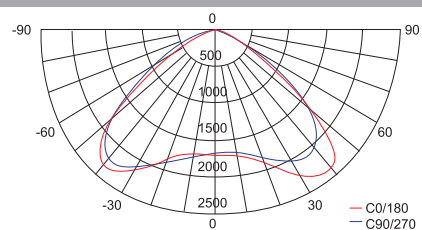

Light Distribution Curve





JB-GN007H1
201630614556.X

Technology information

Product Code	JB-GN007G1	JB-GN007G2	JB-GN007H1	JB-GN007H2
Lamp size	 120 × 120mm	 120 × 120mm	 100 × 100mm	 100 × 100mm
Product height	4M-6M	4M-6M	3M-4M	3M-4M
Power	30W - 60W	30W - 60W	20W / 30W	20W / 30W
Lamp material	6063 Aluminum material			
Color temp	3000K / 6000K			
Strip color temp	Blue / Green / Red / Pink / Warm white			
LED chips	PHILIPS / CREE / BRIGDELUX			
Power supply	PHILIPS driver / MW driver from taiwan / MOSO®			
Lens angle	120°70°			
Efficiency	87%			
Input voltage	AC85-265V			
Protection levels	IP65			



LED Garden Light



Product description

Material and Technology:

- The product design creating is concise and fashion/delicate and elegant/classics and romantic/perfect combination and city beautification.
- The lamp body using for 6063 aluminum material,the lamp pole is high tenacity and metal material will be high reclaim.
- The light source with high quality LED chips and power supply,the lamp pole two side with LED strip for color:red/blue/green/yellow/white and RGB full color change.
- The lamp pole with Nano multi-fanctional coating/prevent paste/prevent scrawl/prevent scratching.
- The lamp application places:public garden/bussiness area/luxury villa garden/ park/plaza/pavements of road ,etc.

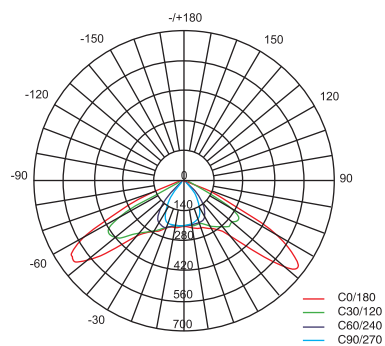

Light Distribution Curve



JB-GN008G1
201730215716.8



Technology information

Product Code	JB-GN008G1	JB-GN008H1
Lamp size	 120 × 120mm	 100 × 100mm
Product height	4M-6M	3M-4M
Power	30W - 60W	20W / 30W
Lamp material	6063 Aluminum material	
Color temp	3000K / 6000K	
Strip color temp	Blue / Green / Red / Pink / Warm white	
LED chips	PHILIPS / CREE / BRIGDELUX	
Power supply	PHILIPS driver / MW driver from taiwan / MOSO [®]	
Lens angle	120°70°	
Efficiency	87%	
Input voltage	AC85-265V	
Protection levels	IP65	



LED Garden Light

Product description

Material and Technology:

- The product design creating is concise and fashion/delicate and elegant/classics and romantic/perfect combination and city beautification.
- The lamp body using for 6063 aluminum material,the lamp pole is high tenacity and metal material will be high reclaim.
- The light source with high quality LED chips and power supply,the lamp pole two side with LED strip for color:red/blue/green/yellow/white and RGB full color change.
- The lamp pole with Nano multi-fanctional coating/prevent paste/prevent scrawl/prevent scratching.
- The lamp application places:public garden/bussiness area/luxury villa garden/ park/plaza/pavements of road ,etc.

Light Distribution Curve

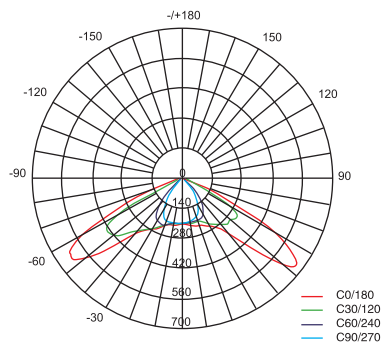

JB-GN009D1
201730215704.5



Technology information

Product Code	JB-GN009D1
Lamp size	 130 × 130 × 130mm
Product height	3M-4M
Power	30W
Lamp material	6063 Aluminum material
Color temp	3000K / 6000K
Strip color temp	Blue / Green / Red / Pink / Warm white
LED chips	PHILIPS / CREE / BRIGDELUX
Power supply	PHILIPS driver / MW driver from taiwan / MOSO [®]
Lens angle	120°70°
Efficiency	87%
Input voltage	AC85-265V
Protection levels	IP65



LED Garden Light

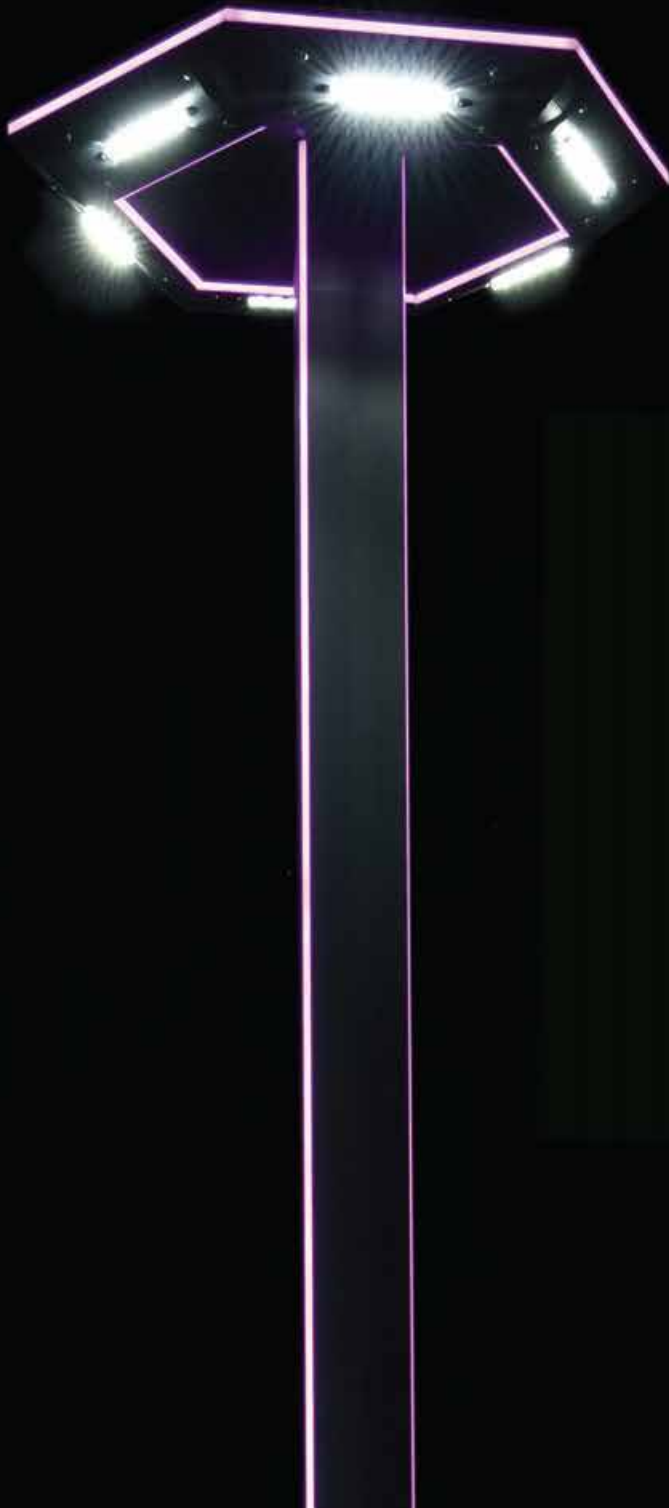

Product description

Material and Technology:

- The product design creating is concise and fashion/delicate and elegant/classics and romantic/perfect combination and city beautification.
- The lamp body using for 6063 aluminum material,the lamp pole is high tenacity and metal material will be high reclaim.
- The light source with high quality LED chips and power supply,the lamp pole two side with LED strip for color:red/blue/green/yellow/white and RGB full color change.
- The lamp pole with Nano multi-fanctional coating/prevent paste/prevent scrawl/prevent scratching.
- The lamp application places:public garden/business area/luxury villa garden/ park/plaza/pavements of road ,etc.

Light Distribution Curve

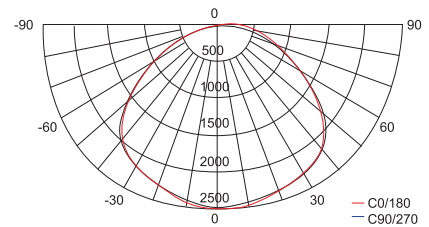

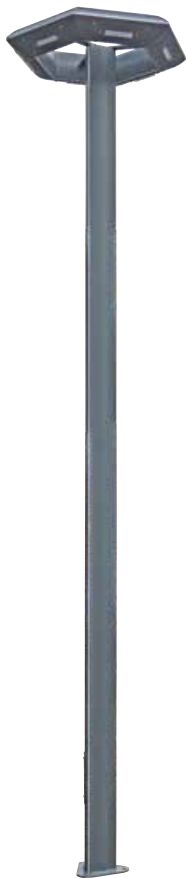



JB-GN117D1
201730215694.5



JB-GN118H1

Technology information

Product Code	JB-GN117D1	JB-GN118H1
Lamp size	 130 × 130 × 130mm	 120 × 120mm
Product height	3M-4M	3M-4M
Power	30W	48W
Lamp material	6063 Aluminum material	
Color temp	3000K / 6000K	
Strip color temp	Blue / Green / Red / Pink / Warm white	
LED chips	PHILIPS / CREE / BRIGDELUX	
Power supply	PHILIPS driver / MW driver from taiwan / MOSO®	
Lens angle	120°70°	
Efficiency	87%	
Input voltage	AC85-265V	
Protection levels	IP65	



LED

Garden Light



JB-GN119A2
201730215693.0

Product description

Material and Technology:

- The product design creating is concise and fashion/delicate and elegant/classics and romantic/perfect combination and city beautification.
- The lamp body using for 6063 aluminum material,the lamp pole is high tenacity and metal material will be high reclaim.
- The light source with high quality LED chips and power supply,the lamp pole two side with LED strip for color:red/blue/green/yellow/white and RGB full color change.
- The lamp pole with Nano multi-functional coating/prevent paste/prevent scrawl/prevent scratching.
- The lamp application places:public garden/bussiness area/luxury villa garden/ park/plaza/pavements of road ,etc.

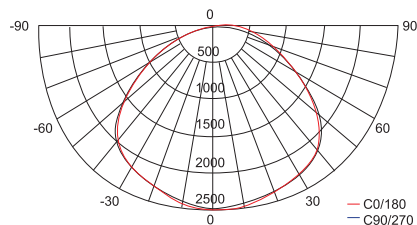

Light Distribution Curve

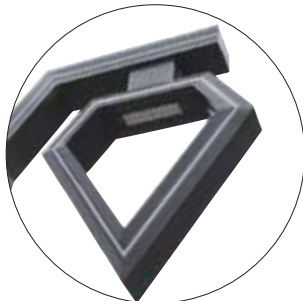
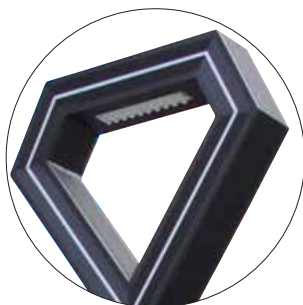

JB-GN119C1
201630614827.1

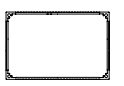

Technology information

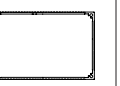
Product Code	JB-GN119A2	JB-GN119C2	JB-GN119A1	JB-GN119C1
Lamp size	 150 × 100mm	 130 × 85mm	 150 × 100mm	 130 × 85mm
Product height	3M-4M	3M-4M	3M-4M	3M-4M
Power	20W / 30W	20W / 30W	20W / 30W	20W / 30W
Lamp material	6063 Aluminum material			
Color temp	3000K / 6000K			
Strip color temp	Blue / Green / Red / Pink / Warm white			
LED chips	PHILIPS / CREE / BRIGDELUX			
Power supply	PHILIPS driver / MW driver from taiwan / MOSO®			
Lens angle	120°/70°			
Efficiency	87%			
Input voltage	AC85-265V			
Protection levels	IP65			



JB-GN128J1
201730215688.X

Product description

Material and Technology:

- The product design creating is concise and fashion/delicate and elegant/classics and romantic/perfect combination and city beautification.
- The lamp body using for 6063 aluminum material,the lamp pole is high tenacity and metal material will be high reclaim.
- The light source with high quality LED chips and power supply,the lamp pole two side with LED strip for color:red/blue/green/yellow/white and RGB full color change.
- The lamp pole with Nano multi-fanctional coating/prevent paste/prevent scrawl/prevent scratching.
- The lamp application places:public garden/bussiness area/luxury villa garden/ park/plaza/pavements of road ,etc.

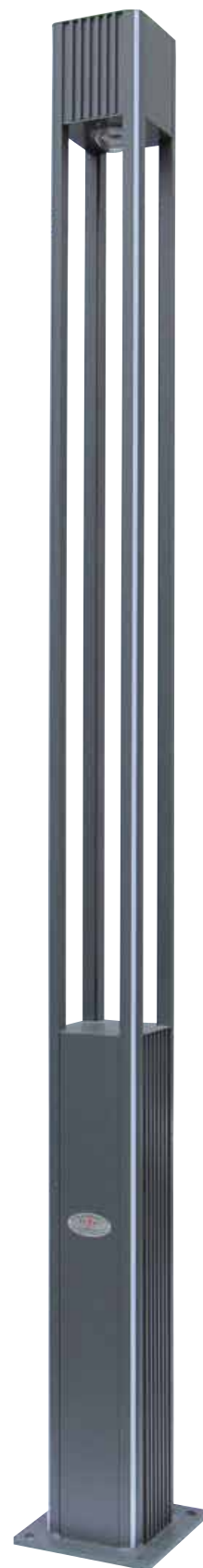
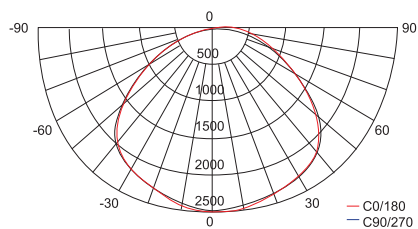

Light Distribution Curve



JB-GN128J2



Technology information

Product Code	JB-GN128J1	JB-GN128J2
Lamp size	 200 × 200mm	 200 × 200mm
Product height	3M-6M	3M-6M
Power	20W - 50W	20W / 60W
Lamp material	6063 Aluminum material	
Color temp	3000K / 6000K	
Strip color temp	Blue / Green / Red / Pink / Warm white	
LED chips	PHILIPS / CREE / BRIGDELUX	
Power supply	PHILIPS driver / MW driver from taiwan / MOSO®	
Lens angle	120°70°	
Efficiency	87%	
Input voltage	AC85-265V	
Protection levels	IP65	



Product description

Material and Technology:

- The product design creating is concise and fashion/delicate and elegant/classics and romantic/perfect combination and city beautification.
- The lamp body using for 6063 aluminum material,the lamp pole is high tenacity and metal material will be high reclaim.
- The light source with high quality LED chips and power supply,the lamp pole two side with LED strip for color:red/blue/green/yellow/white and RGB full color change.
- The lamp pole with Nano multi-fanctional coating/prevent paste/prevent scrawl/prevent scratching.
- The lamp application places:public garden/business area/luxury villa garden/ park/plaza/pavements of road ,etc.

Light Distribution Curve

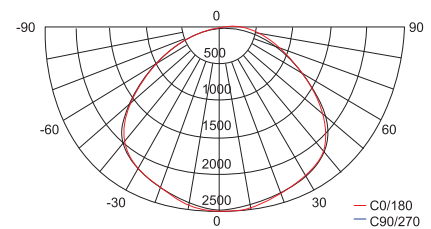

JB-GN127B1
201630614805.5



Technology information

Product Code	JB-GN127B1
Lamp size	 300 × 150mm
Product height	3M-6M
Power	20W - 50W
Lamp material	6063 Aluminum material
Color temp	3000K / 6000K
Strip color temp	Blue / Green / Red / Pink / Warm white
LED chips	PHILIPS / CREE / BRIGDELUX
Power supply	PHILIPS driver / MW driver from taiwan / MOSO®
Lens angle	120°70°
Efficiency	87%
Input voltage	AC85-265V
Protection levels	IP65

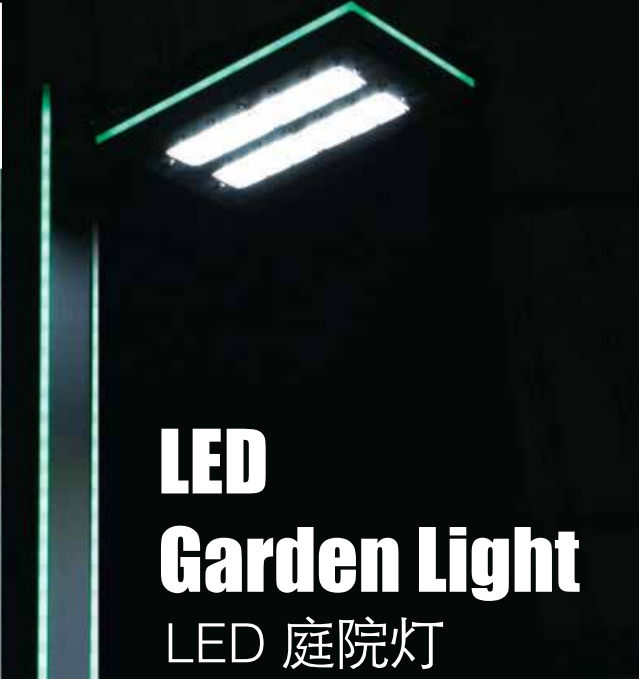

LED Garden Light

LED 庭院灯

Product description

Material and Technology:

- The product design creating is concise and fashion/delicate and elegant/classics and romantic/perfect combination and city beautification.
- The lamp body using for 6063 aluminum material,the lamp pole is high tenacity and metal material will be high reclaim.
- The light source with high quality LED chips and power supply,the lamp pole two side with LED strip for color:red/blue/green/yellow/white and RGB full color change.
- The lamp pole with Nano multi-fanctional coating/prevent paste/prevent scrawl/prevent scratching.
- The lamp application places:public garden/bussiness area/luxury villa garden/ park/plaza/pavements of road ,etc.



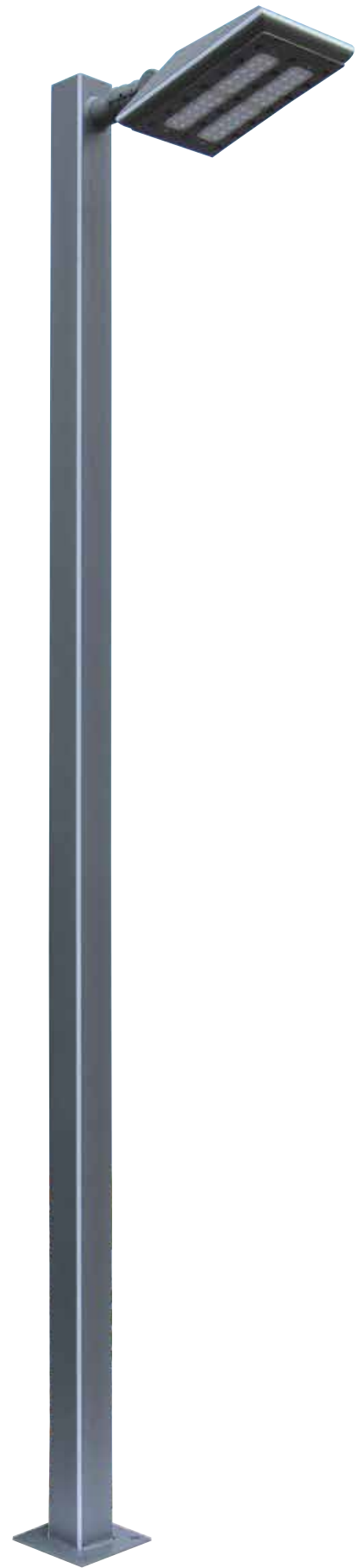
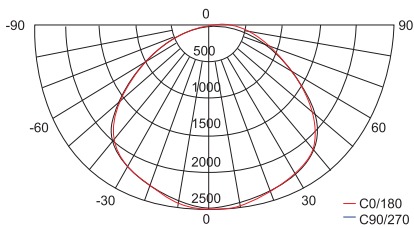

Light Distribution Curve



JB-GN8011H1



Technology information

Product Code	JB-GN8011G1	JB-GN8011H1
Lamp size	 120 × 120mm	 100 × 100mm
Product height	3M-6M	3M-4M
Power	40W - 80W	40W / 60W
Lamp material	6063 Aluminum material	
Color temp	3000K / 6000K	
Strip color temp	Blue / Green / Red / Pink / Warm white	
LED chips	PHILIPS / CREE / BRIGDELUX	
Power supply	PHILIPS driver / MW driver from taiwan / MOSO®	
Lens angle	120°70°	
Efficiency	87%	
Input voltage	AC85-265V	
Protection levels	IP65	



LED Garden Light

Product description

Material and Technology:

- The product design creating is concise and fashion/delicate and elegant/classics and romantic/perfect combination and city beautification.
- The lamp body using for 6063 aluminum material,the lamp pole is high tenacity and metal material will be high reclaim.
- The light source with high quality LED chips and power supply,the lamp pole two side with LED strip for color:red/blue/green/yellow/white and RGB full color change.
- The lamp pole with Nano multi-fanfctional coating/prevent paste/prevent scrawl/prevent scratching.
- The lamp application places:public garden/bussiness area/luxury villa garden/ park/plaza/pavements of road ,etc.

Light Distribution Curve

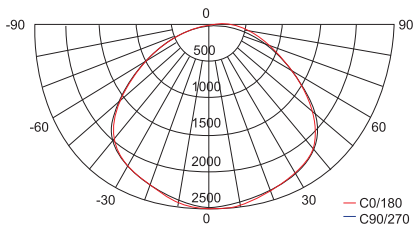



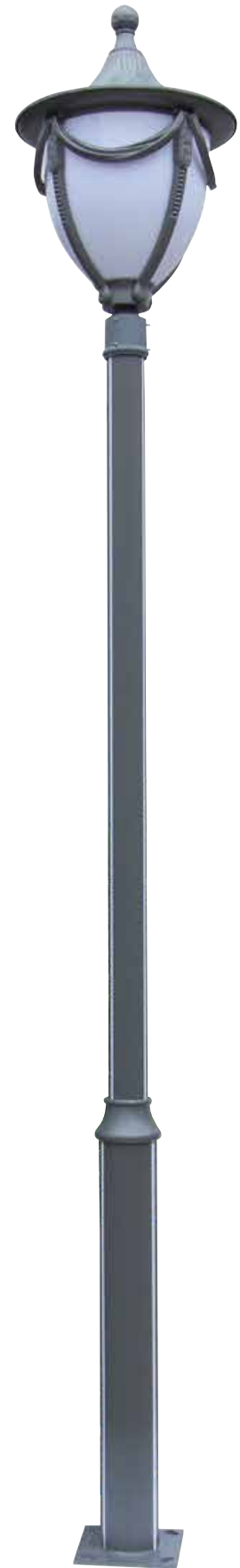

JB-GN103Z3



JB-GN103Z25



Technology information

Product Code	JB-GN103Z3		JB-GN103Z25	
Lamp size	 Φ 114mm+Φ 76mm	 Φ 140mm+Φ 89mm	 Φ 114mm+Φ 76mm	 Φ 140mm+Φ 89mm
Product height	3M-3.5M	3.5M-4M	3M-3.5M	3.5M-4M
Power	30W		30W	
Lamp material	6063 Aluminum material			
Color temp	3000K / 6000K			
Strip color temp	Blue / Green / Red / Pink / Warm white			
LED chips	PHILIPS / CREE / BRIGDELUX			
Power supply	PHILIPS driver / MW driver from taiwan / MOSO®			
Lens angle	120°70°			
Efficiency	87%			
Input voltage	AC85-265V			
Protection levels	IP65			

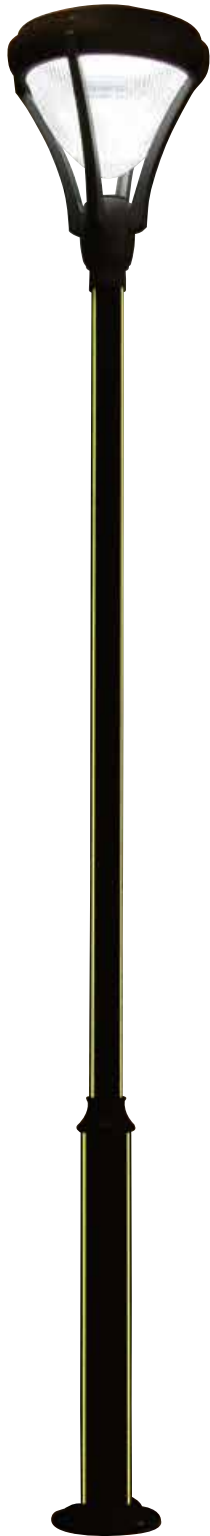

JB-GN103Z5

LED Garden Light

Product description

Material and Technology:

- The product design creating is concise and fashion/delicate and elegant/classics and romantic/perfect combination and city beautification.
- The lamp body using for 6063 aluminum material,the lamp pole is high tenacity and metal material will be high reclaim.
- The light source with high quality LED chips and power supply,the lamp pole two side with LED strip for color:red/blue/green/yellow/white and RGB full color change.
- The lamp pole with Nano multi-fanctional coating/prevent paste/prevent scrawl/prevent scratching.
- The lamp application places:public garden/bussiness area/luxury villa garden/ park/plaza/pavements of road ,etc.



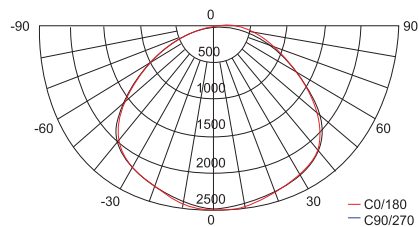

JB-GN103Z4

Light Distribution Curve



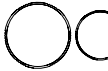
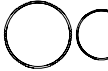

Technology information

Product Code	JB-GN103Z4		JB-GN103Z5	
Lamp size	 Ø114mm+Ø76mm	 Ø140mm+Ø89mm	 Ø114mm+Ø76mm	 Ø140mm+Ø89mm
Product height	3M-3.5M	3.5M-4M	3M-3.5M	3.5M-4M
Power	30W		30W	
Lamp material	6063 Aluminum material			
Color temp	3000K / 6000K			
Strip color temp	Blue / Green / Red / Pink / Warm white			
LED chips	PHILIPS / CREE / BRIGDELUX			
Power supply	PHILIPS driver / MW driver from taiwan / MOSO®			
Lens angle	120*70°			
Efficiency	87%			
Input voltage	AC85-265V			
Protection levels	IP65			



LED Garden Light



Product description

Material and Technology:

- The product design creating is concise and fashion/delicate and elegant/classics and romantic/perfect combination and city beautification.
- The lamp body using for 6063 aluminum material,the lamp pole is high tenacity and metal material will be high reclaim.
- The light source with high quality LED chips and power supply,the lamp pole two side with LED strip for color:red/blue/green/yellow/white and RGB full color change.
- The lamp pole with Nano multi-fanctional coating/prevent paste/prevent scrawl/prevent scratching.
- The lamp application places:public garden/bussiness area/luxury villa garden/ park/plaza/pavements of road , etc.

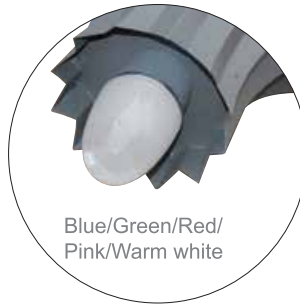

Blue/Green/Red/
Pink/Warm white



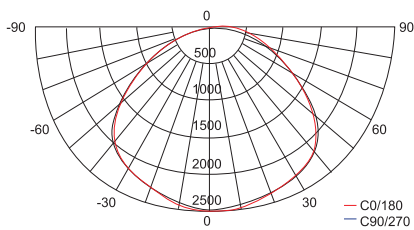

Light Distribution Curve



JB-GN103Z10



Technology information

Product Code	JB-GN103Z10	
Lamp size	 $\Phi 114\text{mm} + \Phi 76\text{mm}$	 $\Phi 140\text{mm} + \Phi 89\text{mm}$
Product height	3M-3.5M	3.5M-4M
Power	30W + 3W	
Lamp material	6063 Aluminum material	
Color temp	3000K / 6000K	
Strip color temp	Blue / Green / Red / Pink / Warm white	
LED chips	PHILIPS / CREE / BRIGDELUX	
Power supply	PHILIPS driver / MW driver from taiwan / MOSO®	
Lens angle	120°70°	
Efficiency	87%	
Input voltage	AC85-265V	
Protection levels	IP65	



Product description

Material and Technology:

- The product design creating is concise and fashion/delicate and elegant/classics and romantic/perfect combination and city beautification.
- The lamp body using for 6063 aluminum material,the lamp pole is high tenacity and metal material will be high reclaim.
- The light source with high quality LED chips and power supply,the lamp pole two side with LED strip for color:red/blue/green/yellow/white and RGB full color change.
- The lamp pole with Nano multi-fanctional coating/prevent paste/prevent scrawl/prevent scratching.
- The lamp application places:public garden/bussiness area/luxury villa garden/ park/plaza/pavements of road ,etc.

配光曲线 Light Distribution Curve

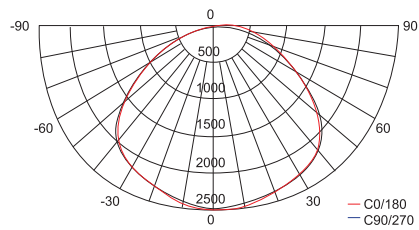





平均光束角 (50%):102.7 度





Technology information

Product Code	JB-GN103Z21		JB-GN103Z11	
Lamp size	 Φ114mm+Φ76mm	 Φ140mm+Φ89mm	 Φ114mm+Φ76mm	 Φ140mm+Φ89mm
Product height	3M-3.5M	3.5M-4M	3M-3.5M	3.5M-4M
Power	30W		36W	
Lamp material	6063 Aluminum material			
Color temp	3000K / 6000K			
Strip color temp	Blue / Green / Red / Pink / Warm white			
LED chips	PHILIPS / CREE / BRIGDELUX			
Power supply	PHILIPS driver / MW driver from taiwan / MOSO®			
Lens angle	120°70°			
Efficiency	87%			
Input voltage	AC85-265V			
Protection levels	IP65			

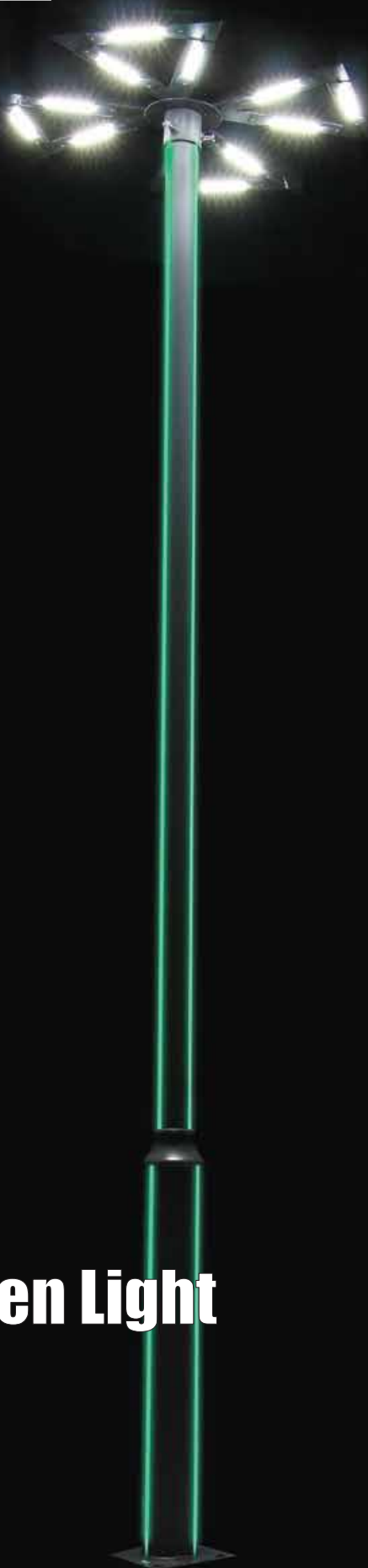

LED Garden Light

Product description

Material and Technology:

- The product design creating is concise and fashion/delicate and elegant/classics and romantic/perfect combination and city beautification.
- The lamp body using for 6063 aluminum material,the lamp pole is high tenacity and metal material will be high reclaim.
- The light source with high quality LED chips and power supply,the lamp pole two side with LED strip for color:red/blue/green/yellow/white and RGB full color change.
- The lamp pole with Nano multi-fancional coating/prevent paste/prevent scrawl/prevent scratching.
- The lamp application places:public garden/bussiness area/luxury villa garden/ park/plaza/pavements of road ,etc.

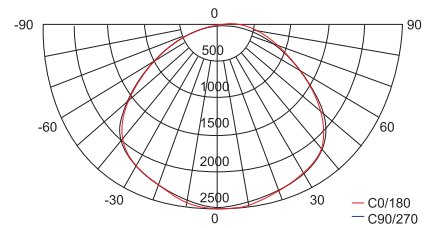

Light Distribution Curve





JB-GN103Z23

Technology information

Product Code	JB-GN103Z23	
Lamp size	 $\Phi 114\text{mm} + \Phi 76\text{mm}$	 $\Phi 140\text{mm} + \Phi 89\text{mm}$
Product height	3M-3.5M	3.5M-4M
Power	60W	
Lamp material	6063 Aluminum material	
Color temp	3000K / 6000K	
Strip color temp	Blue / Green / Red / Pink / Warm white	
LED chips	PHILIPS / CREE / BRIGDELUX	
Power supply	PHILIPS driver / MW driver from taiwan / MOSO [®]	
Lens angle	120°70°	
Efficiency	87%	
Input voltage	AC85-265V	
Protection levels	IP65	



JB-GG021R6



JB-GG021R1



Product description

Material and Technology:

- The product design creating is concise and fashion/delicate and elegant/classics and romantic/perfect combination and city beautification.
- The lamp body using for 6063 aluminum material,the lamp pole is high tenacity and metal material will be high reclaim.
- The light source with high quality LED chips and power supply,the lamp pole two side with LED strip for color:red/blue/green/yellow/white and RGB full color change.
- The lamp pole with Nano multi-fanctional coating/prevent paste/prevent scrawl/prevent scratching.
- The lamp application places:public garden/bussiness area/luxury villa garden/ park/plaza/pavements of road ,etc.



Technology information

Product Code	JB-GG021R1	JB-GG021R6
Lamp size	 Φ 76mm	 Φ 76mm
Product height	80CM	80CM
Power	5W	5W
Lamp material	6063 Aluminum material	
Color temp	3000K / 6000K	
Strip color temp	Blue / Green / Red / Pink / Warm white	
LED chips	CREE	
Power supply	JUNBO driver	
Efficiency	87%	
Input voltage	AC85-265V	
Protection levels	IP65	



JB-GG021X2



JB-GG021X5



JB-GG021Y3

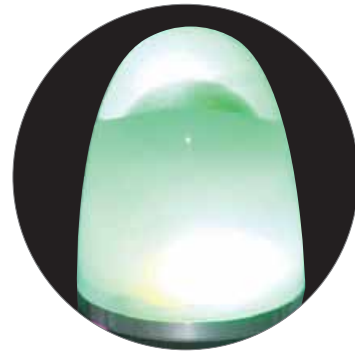

Product description

Material and Technology:

- The product design creating is concise and fashion/delicate and elegant/classics and romantic/perfect combination and city beautification.
- The lamp body using for 6063 aluminum material,the lamp pole is high tenacity and metal material will be high reclaim.
- The light source with high quality LED chips and power supply,the lamp pole two side with LED strip for color:red/blue/green/yellow/white and RGB full color change.
- The lamp pole with Nano multi-fanctional coating/prevent paste/prevent scrawl/prevent scratching.
- The lamp application places:public garden/bussiness area/luxury villa garden/ park/plaza/pavements of road ,etc.



Technology information

Product Code	JB-GG025X2	JB-GG025X5	JB-GG021Y3
Lamp size	 Φ 89mm	 Φ 89mm	 Φ 114mm
Product height	80CM	80CM	80CM
Power	7W	7W	9W
Lamp material	6063 Aluminum material		
Color temp	3000K / 6000K		
Strip color temp	Blue / Green / Red / Pink / Warm white		
LED chips	CREE		
Power supply	JUNBO driver		
Efficiency	87%		
Input voltage	AC85-265V		
Protection levels	IP65		



JB-GG026G4
201630610590.X



JB-GG028C2
201730215689.4





JB-GG027B2
201730215690.7

Product description

Material and Technology:

- The product design creating is concise and fashion/delicate and elegant/classics and romantic/perfect combination and city beautification.
- The lamp body using for 6063 aluminum material,the lamp pole is high tenacity and metal material will be high reclaim.
- The light source with high quality LED chips and power supply,the lamp pole two side with LED strip for color:red/blue/green/yellow/white and RGB full color change.
- The lamp pole with Nano multi-fanctional coating/prevent paste/prevent scrawl/prevent scratching.
- The lamp application places:public garden/bussiness area/luxury villa garden/ park/plaza/pavements of road ,etc.

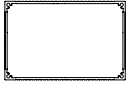
Technology information

Product Code	JB-GG026G4	JB-GG028C2	JB-GG027B2
Lamp size	 120 × 120mm	 130 × 85mm	 150 × 75mm
Product height	80CM	80CM	80CM
Power	12W	8W	8W
Lamp material	6063 Aluminum material		
Color temp	3000K / 6000K		
Strip color temp	Blue / Green / Red / Pink / Warm white		
LED chips	BRIGDELUX		
Power supply	JUNBO driver		
Efficiency	87%		
Input voltage	AC85-265V		
Protection levels	IP65		





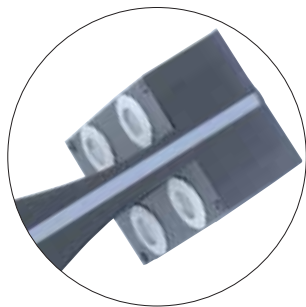

JB-GG017A1
201530149560.9



JB-GG019A1
201530149558.1

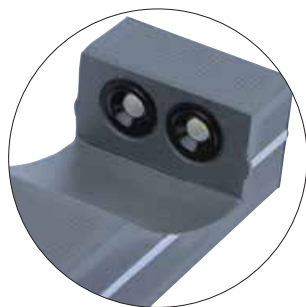

Product description

Material and Technology:

- The product design creating is concise and fashion/delicate and elegant/classics and romantic/perfect combination and city beautification.
- The lamp body using for 6063 aluminum material,the lamp pole is high tenacity and metal material will be high reclaim.
- The light source with high quality LED chips and power supply,the lamp pole two side with LED strip for color:red/blue/green/yellow/white and RGB full color change.
- The lamp pole with Nano multi-fancional coating/prevent paste/prevent scrawl/prevent scratching.
- The lamp application places:public garden/bussiness area/luxury villa garden/ park/plaza/pavements of road ,etc.

Technology information

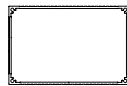
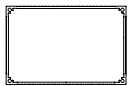
Product Code	JB-GG017A1	JB-GG019A1
Lamp size	 150*100mm	 150*100mm
Product height	80CM	80CM
Power	6W	12W
Lamp material	6063 Aluminum material	
Color temp	3000K / 6000K	
Strip color temp	Blue / Green / Red / Pink / Warm white	
LED chips	BRIGDELUX	
Power supply	JUNBO driver	
Efficiency	87%	
Input voltage	AC85-265V	
Protection levels	IP65	





JB-GG025J1



JB-GG025J2





JB-GG025J3

Product description

Material and Technology:

- The product design creating is concise and fashion/delicate and elegant/classics and romantic/perfect combination and city beautification.
- The lamp body using for 6063 aluminum material, the lamp pole is high tenacity and metal material will be high reclaim.
- The light source with high quality LED chips and power supply, the lamp pole two side with LED strip for color:red/blue/green/yellow/white and RGB full color change.
- The lamp pole with Nano multi-functional coating/prevent paste/prevent scrawl/prevent scratching.
- The lamp application places:public garden/bussiness area/luxury villa garden/ park/plaza/pavements of road ,etc.

Technology information

Product Code	JB-GG025J1	JB-GG025J2	JB-GG025J3
Lamp size	 200*200mm	 200*200mm	 200*200mm
Product height	80CM	80CM	80CM
Power	10W	10W	10W
Lamp material	6063 Aluminum material		
Color temp	3000K / 6000K		
Strip color temp	Blue / Green / Red / Pink / Warm white		
LED chips	PHILIPS / BRIGDELUX		
Power supply	JUNBO driver		
Efficiency	87%		
Input voltage	AC85-265V		
Protection levels	IP65		





JB-GG029C1

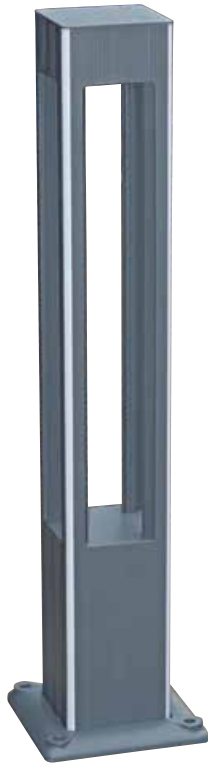

JB-GG030G1

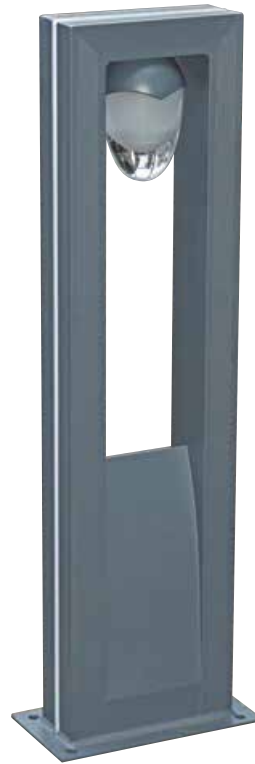

JB-GG023I2



JB-GG031D1





Product description

Material and Technology:

- The product design creating is concise and fashion/delicate and elegant/classics and romantic/perfect combination and city beautification.
- The lamp body using for 6063 aluminum material,the lamp pole is high tenacity and metal material will be high reclaim.
- The light source with high quality LED chips and power supply,the lamp pole two side with LED strip for color:red/blue/green/yellow/white and RGB full color change.
- The lamp pole with Nano multi-fanctional coating/prevent paste/prevent scrawl/prevent scratching.
- The lamp application places:public garden/bussiness area/luxury villa garden/ park/plaza/pavements of road ,etc.

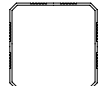

Technology information

Product Code	JB-GG029C1	JB-GG030G1	JB-GG023I2	JB-GG031D1
Lamp size	 130 × 85mm	 120 × 120mm	 200 × 80mm	 130 × 130 × 130mm
Product height	80CM	80CM	80CM	80CM
Power	5W	5W	10W	5W
Lamp material	6063 Aluminum material			
Color temp	3000K / 6000K			
Strip color temp	Blue / Green / Red / Pink / Warm white			
LED chips	CREE			
Power supply	JUNBO driver			
Efficiency	87%			
Input voltage	AC85-265V			
Protection levels	IP65			



JB-GG02311



JB-GG002G1

Product description



Material and Technology:

- The product design creating is concise and fashion/delicate and elegant/classics and romantic/perfect combination and city beautification.
- The lamp body using for 6063 aluminum material,the lamp pole is high tenacity and metal material will be high reclaim.
- The light source with high quality LED chips and power supply,the lamp pole two side with LED strip for color:red/blue/green/yellow/white and RGB full color change.
- The lamp pole with Nano multi-functional coating/prevent paste/prevent scrawl/prevent scratching.
- The lamp application places:public garden/bussiness area/luxury villa garden/ park/plaza/pavements of road ,etc.



JB-GG022B1

Technology information

Product Code	JB-GG002311	JB-GG002G1	JB-022B1
Lamp size	 180*80mm	 120*120mm	 150*75mm
Product height	80CM	80CM	80CM
Power	3W	9W	10W
Lamp material	6063 Aluminum material		
Color temp	3000K / 6000K		
Strip color temp	Blue / Green / Red / Pink / Warm white		
LED chips	PHILIPS / BRIGDELUX		
Power supply	JUNBO driver		
Efficiency	87%		
Input voltage	AC85-265V		
Protection levels	IP65		

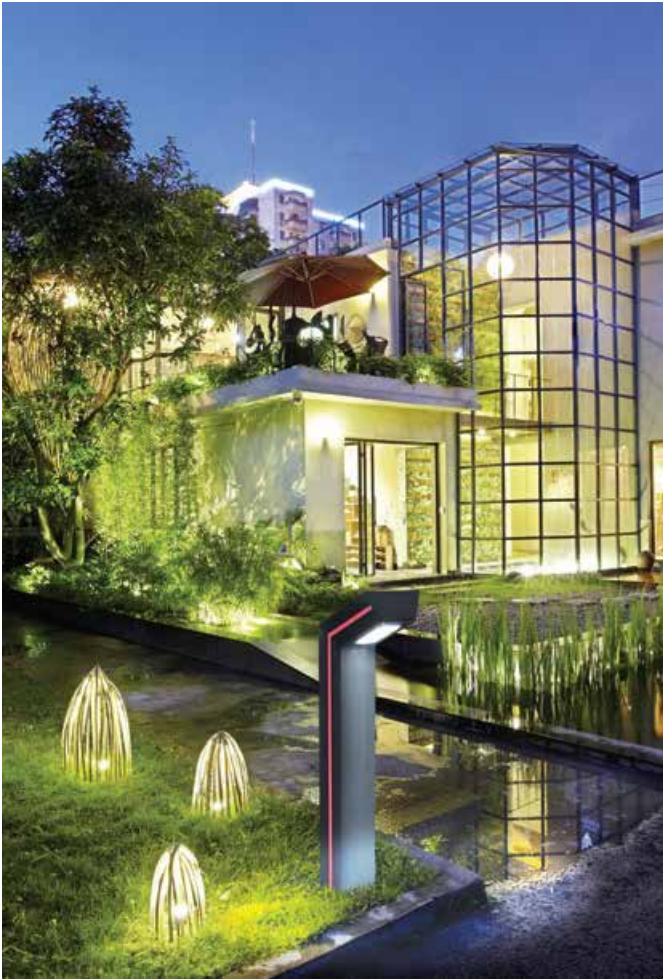



JB-W101R1



JB-W106R1



JB-W106R2

Product description

Material and Technology:

- The product design creating is concise and fashion/delicate and elegant/classics and romantic/perfect combination and city beautification.
- The lamp body using for 6063 aluminum material,the lamp pole is high tenacity and metal material will be high reclaim.
- The light source with high quality LED chips and power supply,the lamp pole two side with LED strip for color:red/blue/green/yellow/white and RGB full color change.
- The lamp pole with Nano multi-functional coating/prevent paste/prevent scrawl/prevent scratching.
- The lamp application places:public garden/bussiness area/luxury villa garden/ park/plaza/pavements of road ,etc.

Technology information

Product Code	JB-W101R1	JB-W106R1	JB-W106R2
Lamp size	 Φ 76mm	 Φ 76mm	 Φ 76mm
Power	5W	5W	2*5W
Lamp material	6063 Aluminum material		
Color temp	3000K / 6000K		
Strip color temp	Blue / Green / Red / Pink / Warm white		
LED chips	CREE		
Power supply	JUNBO driver		
Efficiency	87%		
Input voltage	AC85-265V		
Protection levels	IP65		





JB-W102X1



JB-W102X1D
201630614607.9

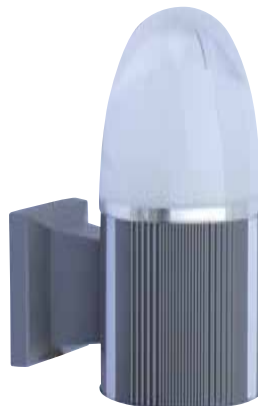

JB-W105X1





Product description

Material and Technology:

- The product design creating is concise and fashion/delicate and elegant/classics and romantic/perfect combination and city beautification.
- The lamp body using for 6063 aluminum material,the lamp pole is high tenacity and metal material will be high reclaim.
- The light source with high quality LED chips and power supply,the lamp pole two side with LED strip for color:red/blue/green/yellow/white and RGB full color change.
- The lamp pole with Nano multi-fanctional coating/prevent paste/prevent scrawl/prevent scratching.
- The lamp application places:public garden/bussiness area/luxury villa garden/ park/plaza/pavements of road ,etc.

Technology information

Product Code	JB-W102X1	JB-W102X1D	JB-W105X1
Lamp size	 Φ 89mm	 Φ 89mm	 Φ 89mm
Power	7W	2*7W	7W
Lamp material	6063 Aluminum material		
Color temp	3000K / 6000K		
Strip color temp	Blue / Green / Red / Pink / Warm white		
LED chips	CREE		
Power supply	JUNBO driver		
Efficiency	87%		
Input voltage	AC85-265V		
Protection levels	IP65		

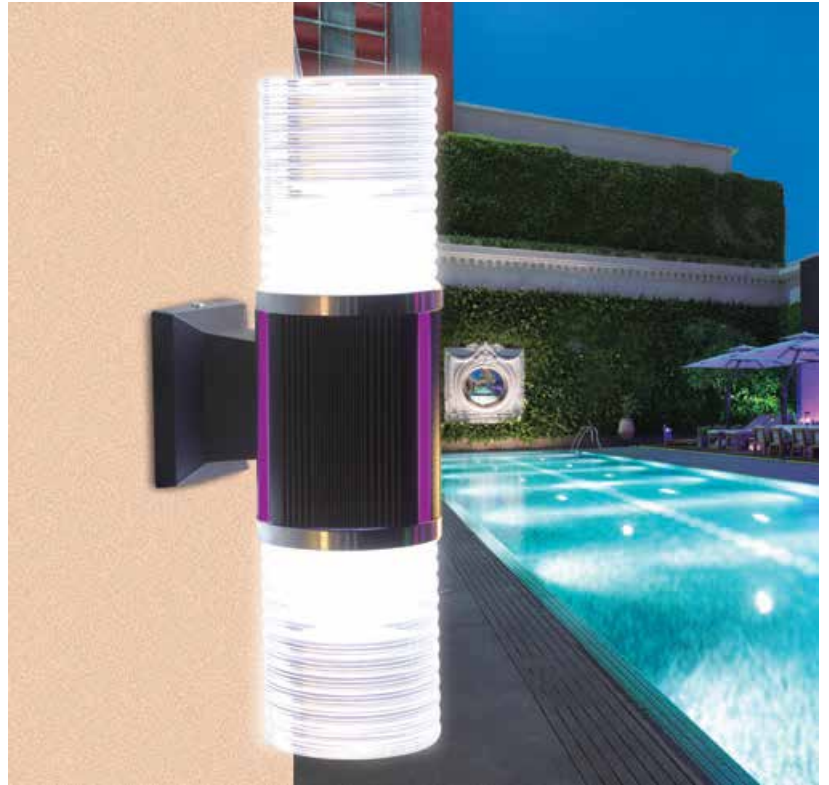

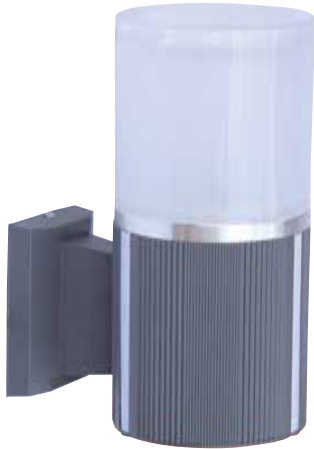

JB-W103Y1
201630614609.8

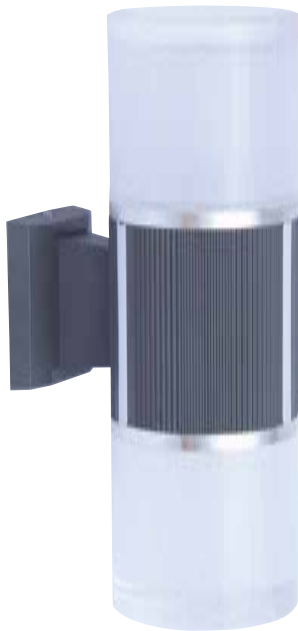

JB-W103Y1D

Product description

Material and Technology:

- The product design creating is concise and fashion/delicate and elegant/classics and romantic/perfect combination and city beautification.
- The lamp body using for 6063 aluminum material,the lamp pole is high tenacity and metal material will be high reclaim.
- The light source with high quality LED chips and power supply,the lamp pole two side with LED strip for color:red/blue/green/yellow/white and RGB full color change.
- The lamp pole with Nano multi-fanctional coating/prevent paste/prevent scrawl/prevent scratching.
- The lamp application places:public garden/bussiness area/luxury villa garden/ park/plaza/pavements of road ,etc.

Technology information

Product Code	JB-W103Y1	JB-W103Y1D
Lamp size	 Φ 114mm	 Φ 114mm
Power	9W	2*9W
Lamp material	6063 Aluminum material	
Color temp	3000K / 6000K	
Strip color temp	Blue / Green / Red / Pink / Warm white	
LED chips	CREE	
Power supply	JUNBO driver	
Efficiency	87%	
Input voltage	AC85-265V	
Protection levels	IP65	



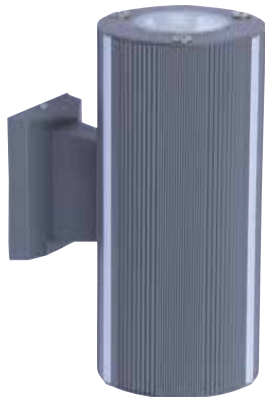

JB-W205Y3D
201630614577.4



JB-W202D3D
201630614558.9



JB-W205Y3







JB-W202D3

Product description

Material and Technology:

- The product design creating is concise and fashion/delicate and elegant/classics and romantic/perfect combination and city beautification.
- The lamp body using for 6063 aluminum material,the lamp pole is high tenacity and metal material will be high reclaim.
- The light source with high quality LED chips and power supply,the lamp pole two side with LED strip for color:red/blue/green/yellow/white and RGB full color change.
- The lamp pole with Nano multi-functional coating/prevent paste/prevent scrawl/prevent scratching.
- The lamp application places:public garden/bussiness area/luxury villa garden/ park/plaza/pavements of road ,etc.

Technology information

Product Code	JB-W205Y3	JB-W205Y3D	JB-W202D3	JB-W202D3D
Lamp size	 Φ 114mm	 Φ 114mm	 130*130*130mm	 130*130*130mm
Power	COB 7W	2*COB 7W	COB 10W	2*COB 10W
Lamp material	6063 Aluminum material			
Color temp	3000K / 6000K			
Strip color temp	Blue / Green / Red / Pink / Warm white			
LED chips	BRIGDELUX			
Power supply	PHILIPS driver / MW driver from taiwan			
Efficiency	87%			
Input voltage	AC85-265V			
Protection levels	IP65			





JB-W207C2D
201630614560.6

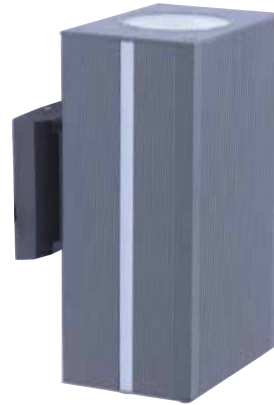

JB-W206A3D
201630614606.4



JB-W207C2

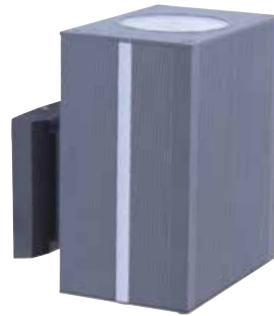

JB-W206A3

Product description

Material and Technology:

- The product design creating is concise and fashion/delicate and elegant/classics and romantic/perfect combination and city beautification.
- The lamp body using for 6063 aluminum material,the lamp pole is high tenacity and metal material will be high reclaim.
- The light source with high quality LED chips and power supply,the lamp pole two side with LED strip for color:red/blue/green/yellow/white and RGB full color change.
- The lamp pole with Nano multi-fanctional coating/prevent paste/prevent scrawl/prevent scratching.
- The lamp application places:public garden/bussiness area/luxury villa garden/ park/plaza/pavements of road ,etc.

Technology information

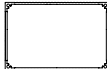
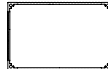
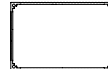
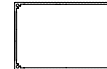
Product Code	JB-W207C2	JB-W207C2D	JB-W206A3	JB-W206A3D
Lamp size	 130*85mm	 130*85mm	 150*100mm	 150*100mm
Power	6W	2*6W	COB 10W	2*COB 10W
Lamp material	6063 Aluminum material			
Color temp	3000K / 6000K			
Strip color temp	Blue / Green / Red / Pink / Warm white			
LED chips	BRIGDELUX			
Power supply	PHILIPS driver / MW driver from taiwan			
Efficiency	87%			
Input voltage	AC85-265V			
Protection levels	IP65			





JB-W208G3D



JB-W208G3
201630614559.3



JB-W209E5D
201630614608.3

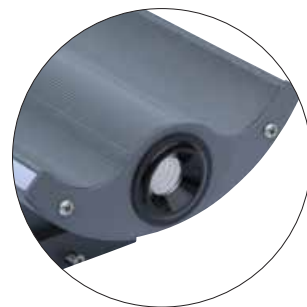



Product description

Material and Technology:

- The product design creating is concise and fashion/delicate and elegant/classics and romantic/perfect combination and city beautification.
- The lamp body using for 6063 aluminum material,the lamp pole is high tenacity and metal material will be high reclaim.
- The light source with high quality LED chips and power supply,the lamp pole two side with LED strip for color:red/blue/green/yellow/white and RGB full color change.
- The lamp pole with Nano multi-fanctional coating/prevent paste/prevent scrawl/prevent scratching.
- The lamp application places:public garden/bussiness area/luxury villa garden/ park/plaza/pavements of road ,etc.

Technology information

Product Code	JB-W208G3	JB-W208G3D	JB-W209E5D
Lamp size	 120*120mm	 120*120mm	 150*60mm
Power	COB 10W	2*COB 10W	2*COB 3W
Lamp material	6063 Aluminum material		
Color temp	3000K / 6000K		
Strip color temp	Blue / Green / Red / Pink / Warm white		
LED chips	CREE		
Power supply	JUNBO driver		
Efficiency	87%		
Input voltage	AC85-265V		
Protection levels	IP65		



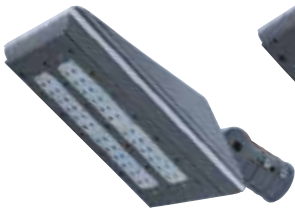

JB-L8011-40W



JB-L8011-60W

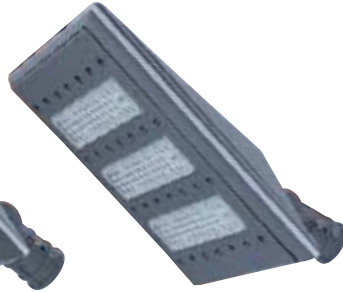

JB-L8011-120W

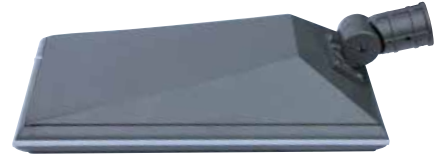

Product description

Material and Technology:

- The product design creating is concise and fashion/delicate and elegant/classics and romantic/perfect combination and city beautification.
- The lamp body using for 6063 aluminum material,the lamp pole is high tenacity and metal material will be high reclaim.
- The light source with high quality LED chips and power supply,the lamp pole two side with LED strip for color:red/blue/green/yellow/white and RGB full color change.
- The lamp pole with Nano multi-fanctional coating/prevent paste/prevent scrawl/prevent scratching.
- The lamp application places:public garden/bussiness area/luxury villa garden/ park/plaza/pavements of road ,etc.



JB-L8011-160W

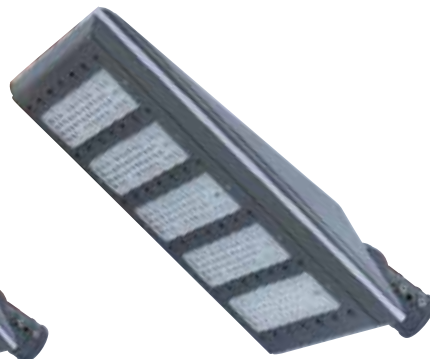

JB-L8011-200W

201730133229.7

Technology information

Product Code	JB-L8011-40W	JB-L8011-60W	JB-L8011-80W	JB-L8011-120W	JB-L8011-160W	JB-L8011-200W
Lamp size	530*360*165mm	530*360*165mm	620*360*165mm	620*360*165mm	720*360*165mm	720*360*165mm
Power	40W	60W	80W	120W	160W	200W
Lamp material	6063 Aluminum material					
Color temp	3000K / 6000K					
Strip color temp	Blue / Green / Red / Pink / Warm white					
LED chips	PHILIPS / CREE					
Power supply	PHILIPS driver / MW driver from taiwan					
Lens Angle	120° - 150°					
Efficiency	87%					
Input voltage	AC85-265V					
Protection levels	IP65					







JB-3608P

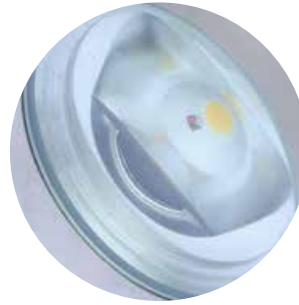

Technology information

Product Code	JB-3608P
Lamp size	Φ180mm
Power	15W
Lamp material	304 Stainless steel + Aluminum + PC
Color temp	3000K / 6000K
LED chips	CREE
Power Supply	MW Driver From Taiwan
Efficiency	87%
Input voltage	AC85-265V
Protection levels	IP65

Product description

Material and Technology:

- The product design creating is concise and fashion/delicate and elegant/classics and romantic/perfect combination and city beautification.
- The lamp body using for 6063 aluminum material,the lamp pole is high tenacity and metal material will be high reclaim.
- The light source with high quality LED chips and power supply,the lamp pole two side with LED strip for color:red/blue/green/yellow/white and RGB full color change.
- The lamp pole with Nano multi-functional coating/prevent paste/prevent scrawl/prevent scratching.
- The lamp application places:public garden/bussiness area/luxury villa garden/ park/plaza/pavements of road ,etc.





JB-3615A3



JB-3615A5



JB-3615A5



JB-3615A9



Technology information

Product Code	JB-3615A3	JB-3615A5	JB-3615A9	JB-3615A3	JB-3615A5	JB-3615A9
Lamp size	Φ100mm	Φ155mm	Φ200mm	Φ100mm	Φ155mm	Φ200mm
Power	3*1W	5*1W/6*1W/7*1W	9*1W/12*1W	COB 3W-5W	COB 7W-15W	COB 20W-30W
Lamp material	304 Stainless steel + Aluminum + PC			304 Stainless steel + Aluminum + PC		
Color temp	3000K / 6000K / Blue / Red / Green			3000K / 6000K		
LED chips	BRIGDELUX			BRIGDELUX		
Power Supply	JUNBO driver			JUNBO driver		
Efficiency	87%			87%		
Input voltage	AC85-265V			AC85-265V		
Protection levels	IP65			IP65		

Product description

Material and Technology:

- The product design creating is concise and fashion/delicate and elegant/classics and romantic/perfect combination and city beautification.
- The lamp body using for 6063 aluminum material,the lamp pole is high tenacity and metal material will be high reclaim.
- The light source with high quality LED chips and power supply,the lamp pole two side with LED strip for color:red/blue/green/yellow/white and RGB full color change.
- The lamp pole with Nano multi-fanctional coating/prevent paste/prevent scrawl/prevent scratching.
- The lamp application places:public garden/bussiness area/luxury villa garden/ park/plaza/pavements of road ,etc.





JB-5615A5

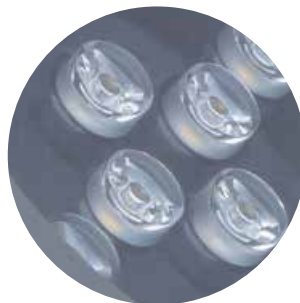

Product description

Material and Technology:

- The product design creating is concise and fashion/delicate and elegant/classics and romantic/perfect combination and city beautification.
- The lamp body using for 6063 aluminum material,the lamp pole is high tenacity and metal material will be high reclaim.
- The light source with high quality LED chips and power supply,the lamp pole two side with LED strip for color:red/blue/green/yellow/white and RGB full color change.
- The lamp pole with Nano multi-fanctional coating/prevent paste/prevent scrawl/prevent scratching.
- The lamp application places:public garden/bussiness area/luxury villa garden/ park/plaza/pavements of road ,etc.



JB-5615A9

Technology information

Product Code	JB-5615A3	JB-5615A5	JB-5615A9	JB-5616C3	JB-5616C5	JB-5616C9
Lamp size	Φ100mm	Φ155mm	Φ200mm	Φ100mm	Φ155mm	Φ200mm
Power	3*1W	5*1W/6*1W/7*1W	9*1W/12*1W	COB 3W-5W	COB 7W-15W	COB 20W-30W
Lamp material	Aluminum			304 Stainless steel + Aluminum + PC		
Color temp	3000K / 6000K / Blue / Red / Green			3000K / 6000K		
LED chips	BRIGDELUX			BRIGDELUX		
Power Supply	JUNBO driver			JUNBO driver		
Efficiency	87%			87%		
Input voltage	AC85-265V			AC85-265V		
Protection levels	IP65			IP65		





luxeralighting.ro

Luxera Lighting SRL
Șos. București - Urziceni, nr. 25, Ilfov
+4 0728 401 242
office@luxeralighting.ro